

Duschtürbeschlag Modesta *shower door hinge Modesta*



10

- *Duschtürbeschlag Modesta/shower door hinge Modesta*
techn. Information/technical information

● Modesta

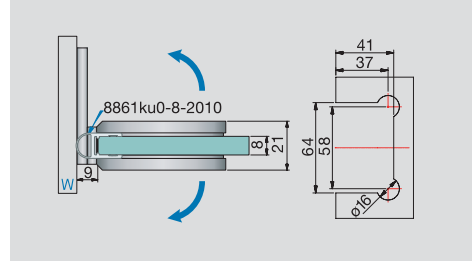
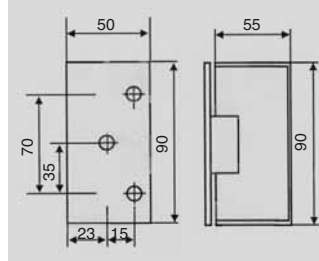

Artikel-Nr. Article-no.	Oberflächen Finishes	Artikelbezeichnung Article name	Glasdicke Glass thickness	Merkmale Features	VE/Stück pu/piece
8450	MS7	Duschtürband, Glas-Wand 90°, beidseitig 90° öffnend/ Shower door hinge, glass-wall 90°, double sided opening 90°	8-12 mm	schließt ab 25° automatisch Tragfähigkeit 50kg (bei 2 Bändern) automatically closed to about 25° load capacity (2 hinges)	1/1

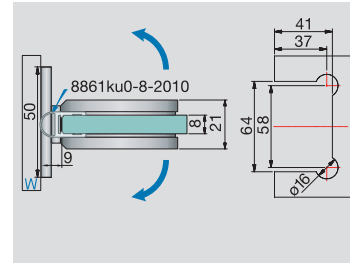
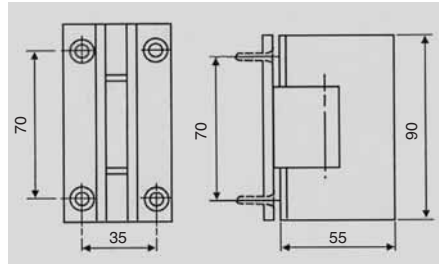

10

Artikel-Nr. Article-no.	Oberflächen Finishes	Artikelbezeichnung Article name	Glasdicke Glass thickness	Merkmale Features	VE/Stück pu/piece
8452	MS7	Duschtürband, Glas-Wand 90°, beidseitig 90° öffnend/ Shower door hinge, glass-wall 90°, double sided opening 90°	8-12 mm	schließt ab 25° automatisch Tragfähigkeit 50kg (bei 2 Bändern) automatically closed to about 25° load capacity (2 hinges)	1/1

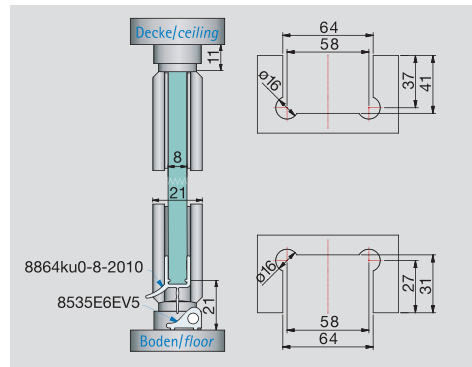
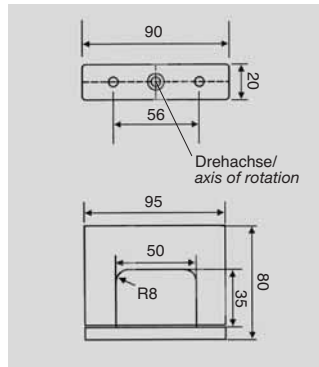

Artikel-Nr. Article-no.	Oberflächen Finishes	Artikelbezeichnung Article name	Glasdicke Glass thickness	Merkmale Features	VE/Stück pu/piece
8454	MS7	Duschtürdrehband, Glas-Bode/ Glas-Decke 360°, beidseitig öffnend/ rotatable shower door hinge, glass-floor/ glass-ceiling 360°, double sided opening	8-12 mm	schließt ab 25° automatisch Tragfähigkeit 50kg (bei 2 Bändern) automatically closed to about 25° load capacity (2 hinges)	1/1

W = Wand/ wall

Modesta

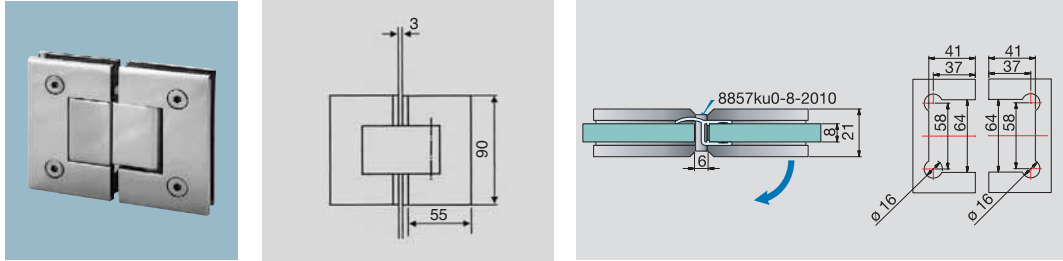

Artikel-Nr. Article-no.	Oberflächen Finishes	Artikelbezeichnung Article name	Glasdicke Glass thickness	Merkmale Features	VE/Stück pu/piece
8456	MS7	Duschtürband, Glas-Glas 180°, beidseitig 90° öffnend/ Shower door hinge, glass-glass 180°, double sided opening 90°	8-12 mm	schließt ab 25° automatisch Tragfähigkeit 50kg (bei 2 Bändern) automatically closed to about 25° load capacity (2 hinges)	1/1

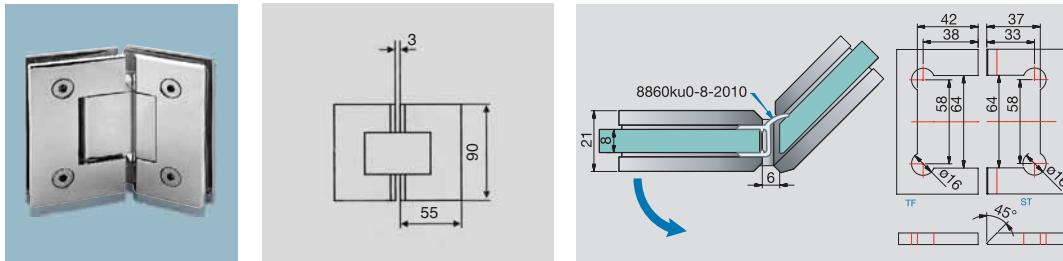

Artikel-Nr. Article-no.	Oberflächen Finishes	Artikelbezeichnung Article name	Glasdicke Glass thickness	Merkmale Features	VE/Stück pu/piece
8458	MS7	Duschtürband, Glas-Glas 135°, beidseitig 90° öffnend/ Shower door hinge, glass-glass 135°, double sided opening 90°	8-12 mm	schließt ab 25° automatisch Tragfähigkeit 50kg (bei 2 Bändern) automatically closed to about 25° load capacity (2 hinges)	1/1

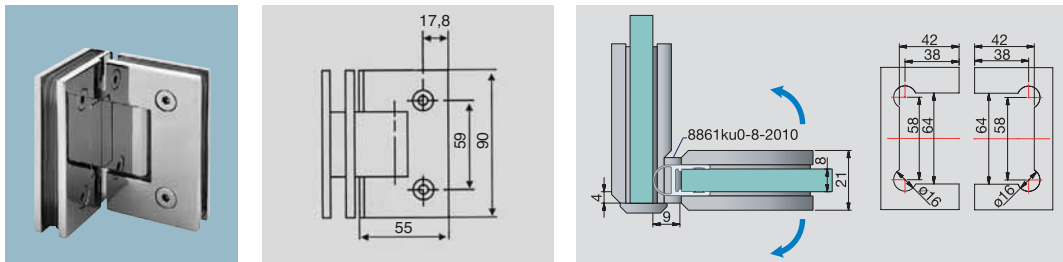

Artikel-Nr. Article-no.	Oberflächen Finishes	Artikelbezeichnung Article name	Glasdicke Glass thickness	Merkmale Features	VE/Stück pu/piece
8460	MS7	Duschtürband, Glas-Glas 90°, beidseitig 90° öffnend/ Shower door hinge, glass-glass 90°, double sided opening 90°	8-12 mm	schließt ab 25° automatisch Tragfähigkeit 50kg (bei 2 Bändern) automatically closed to about 25° load capacity (2 hinges)	1/1

ST = Seitenteil/side panel
TF = Türflügel/ wing of the door

● Modesta

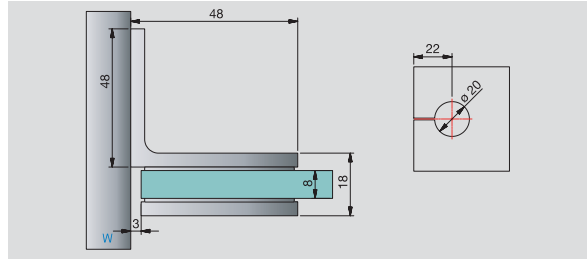
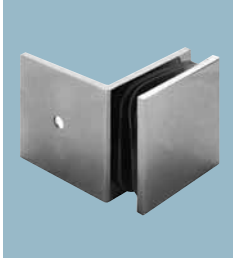

Artikel-Nr. Article-no.	Oberflächen Finishes	Artikelbezeichnung Article name	Glasdicke Glass thickness	Merkmale Features	VE/Stück pu/piece
8462	MS7	Winkelverbinder, Glas-Wand, 90°/ corner bracket, glass-wall, 90°,	8-12 mm	-	1/1

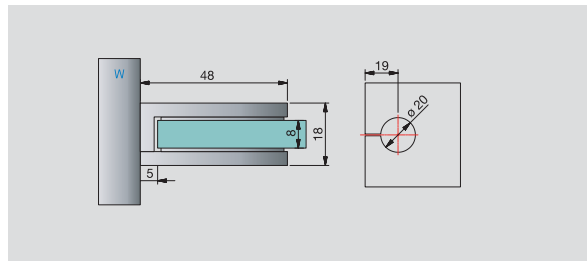

Artikel-Nr. Article-no.	Oberflächen Finishes	Artikelbezeichnung Article name	Glasdicke Glass thickness	Merkmale Features	VE/Stück pu/piece
8464	MS7	Winkelverbinder, Glas-Wand, 90°/ corner bracket, glass-wall, 90°,	8-12 mm	-	1/1

10

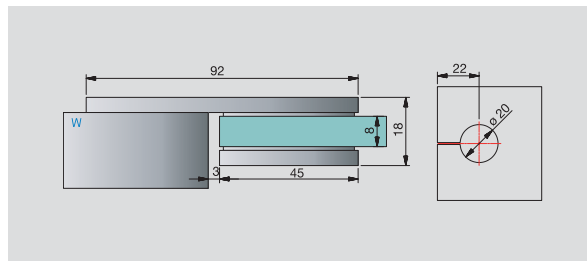

Artikel-Nr. Article-no.	Oberflächen Finishes	Artikelbezeichnung Article name	Glasdicke Glass thickness	Merkmale Features	VE/Stück pu/piece
8466	MS7	Längsverbinder, Glas-Wand, 180°/ inline connector, glass-wall, 180°,	8-12 mm	-	1/1

W = Wand/wall

● Modesta

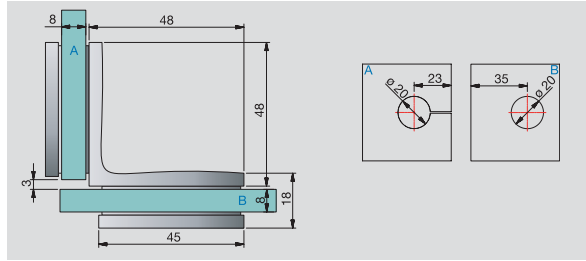

Artikel-Nr. Article-no.	Oberflächen Finishes	Artikelbezeichnung Article name	Glasdicke Glass thickness	Merkmale Features	VE/Stück pu/piece
8468	MS7	Winkelverbinder, Glas-Glas, 90°/ corner bracket, glass-glass, 90°,	8-12 mm	-	1/1

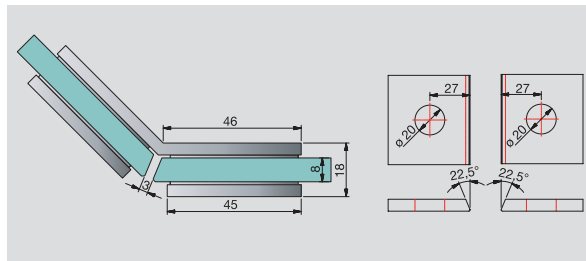

Artikel-Nr. Article-no.	Oberflächen Finishes	Artikelbezeichnung Article name	Glasdicke Glass thickness	Merkmale Features	VE/Stück pu/piece
8470	MS7	Winkelverbinder, Glas-Glas, 135°/ corner bracket, glass-glass, 135°,	8-12 mm	-	1/1

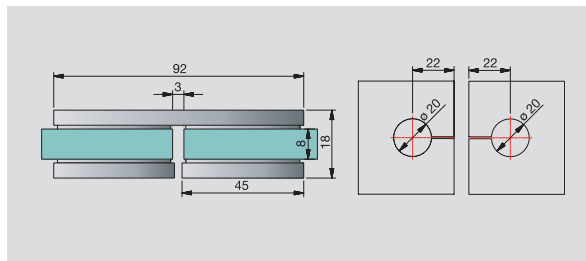

Artikel-Nr. Article-no.	Oberflächen Finishes	Artikelbezeichnung Article name	Glasdicke Glass thickness	Merkmale Features	VE/Stück pu/piece
8472	MS7	Längsverbinder, Glas-Glas, 180°/ inline connector, glass-glass, 180°,	8-12 mm	-	1/1