

Duschtürpendelband Pontere *shower door swing hinge Pontere*



10

- Duschtürpendelband Pontere/
shower doors wing hinge Pontere
Anwendungsbeispiele/*applications*
Produktvorteile/*products benefits*
Einbausituationen/*locations*
Produktinformationen/*product information*
techn. Information/*technical information*

● Pontere

Das Pendeltürband Pontere ist ein wahres Multitalent: Es schließt auf den letzten Zentimetern selbsttätig und kann in seiner Nulllage beliebig oft und stufenlos verstellt werden. Damit ist es der perfekte Partner für individuelle Nischen-, Eck-, Fünfeck-, und U-Duschen sowie Badewannenabtrennungen.

Vorteile, die Sie und Ihre Kunden überzeugen:

- auf den letzten Zentimetern selbstschließendes Duschtürband
- beliebig oft verstellbare Nulllagenstellung
- stufenlos einstellbare Gradzahl
- schnelle Montage
- wartungsfreie Beschläge

The swing door hinge Pontere is a real all-rounder: Shortly before the closed position is achieved, the self closing mechanism is engaged. It has an adjustable self-centering function in the closed position. This makes Pontere a perfect partner for individual niche-, corner-, pentagon- and u-shaped showers, as well as for bathtub applications.

Advantages which convince you and your customers:

- *self closing in the final few centimeters*
- *unlimited adjustment in the closed position*
- *infinite adjustable degree function*
- *quick assembly*
- *maintenance-free fittings*

10



● Pontere



● Pontere

Pontere zeichnet sich durch eine außergewöhnliche Formsprache und Qualität aus. Die geometrisch, klare Kontur des Beschlages stellt eine harmonische Verbindung zum Bad her./Pontere combines extraordinary design with exceptional quality. The geometrical, clear contour of the hinge establishes a harmonic connection to the bathroom.

10



● Pontere

Fakten/Facts

Funktion/Eigenschaft: Das Pontere Pendeltürband schließt auf den letzten Zentimetern selbsttätig und kann in seiner Nulllage beliebig oft und stufenlos verstellt werden. Die Gradzahl der Winkelverbinder ist stufenlos verstellbar. Durch die Nulllagenstellung können die Beschläge schneller montiert werden, auch bei Wänden deren Flucht nicht zu einander steht. Teure Anfertigungen von Sonderwinkeln entfallen, weil für unterschiedlichste Lösungen, verschiedenste Bänder und Winkel entwickelt wurden. Das Pontere Pendeltürband ist wartungsfrei.
function/characteristics: *Shortly before the closed position is achieved, the Pontere swing door hinge self closing mechanism is engaged. Therefore the hinges can be quickly assembled even with slanted walls. Due to our various solutions it is no longer necessary to manufacture expensive parts. The Pontere swing door hinge is maintenance-free.*

Grundmaterial/
base material: - Messing/brass

Oberfläche/finishes: Lieferbar im Standardprogramm/standard program available in:
 Messing - poliert verchromt/brass - polished chrome finish
 Messing - mattverchromt/brass - matt chrome finish
 Messing - edelstahlfinish PVD-beschichtet/ brass - stainless steel finish PVD coated

Tragfähigkeit (2 Bänder)/
load capacity(2 hinges): 50 kg entsprechen einem Glastürflügel von 1000 x 2000 mm bei einer Glasdicke von 10 mm/
 50 kg corresponding to a glass door with the dimension 1000 x 2000 mm and a glass pane thickness of 10 mm

Glasdicke/
glass thickness: 8 und 10 mm/ 8 and 10 mm
 Für die Bänder sind Glasausschnitte erforderlich./For hinges a glass recess is required.

Formgebung/design: Das harmonische Zusammenspiel von Technik und intelligenter Formgebung betont den hohen Designanspruch./The harmonic combination of technique and intelligent contours reflects our high design standards.

Anwendung/
application: Nischenduschen/niche showers
 Eckduschen/corner showers
 5-Eckduschen/5-corner showers
 U-Duschen/u-showers
 Badewannenlösungen/bathtub solutions

Zubehör/Extras:
accessories/extras: Dichtprofile, Duschtürknoöpfe und Griffe, Stabilisationsstangen, Handtuchhalter
 sealing profiles, door knobs and handles, supporters, towel bars

10

Anwendungsbeispiel für Nulllagenverstellung bei Duschtürpendelband 8406MS zum genauen Anpassen der Flucht vom Beschlag zur Wand/Application example adjustable in the closed position with swing door hinge 8406MS for an absolute precise wall fitting.



 Pontere

Das Design von Pontere können Sie auf unterschiedlichste Art genießen, denn es passt sich diversen Einbausituationen flexibel an.

Nischenduschen/*niche showers*



Set-1-101



Set-1-102



Set-1-103



Set-1-104



Set-1-105



Set-1-106

Eckduschen/*corner showers*



Set-1-201



Set-1-202



Set-1-206



Set-1-221



Set-1-205



Set-1-217



Set-1-211



Set-1-210



Set-1-219



Set-1-209



Set-1-204



Set-1-213



Set-1-218



Set-1-220



Set-1-221

 Pontere

You can enjoy the design of Pontere in various ways because it adapts to many different settings.

5-Eck-Duschen/5-corner showers



Set-1-301



Set-1-310



Set-1-311



Set-1-303



Set-1-312



Set-1-313



Set-1-308



Set-1-309



aSet-1-305



Set-1-306



Set-1-304

U-Duschen/U-showers



Set-1-401



Set-1-402



Set-1-403



Set-1-404



Set-1-406

Badewannenlösungen/bath tub solutions



Set-1-615



Set-1-612

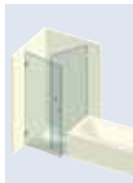

Set-1-611



Set-1-601



Set-1-603



Set-1-617



Set-1-616

Weitere Informationen zu Pontere finden sie in unserem technischen Katalog oder unter www.pauli.de/
 For further information on Pontere please see our technical catalogue or our website: www.pauli.de

● Pontere

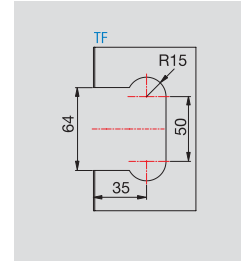
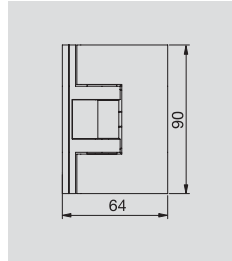
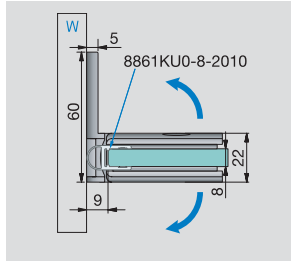
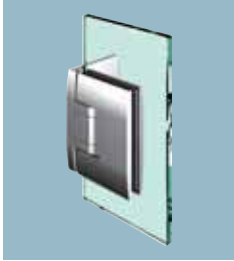

Artikel-Nr. Article-no.	Oberflächen Finishes	Artikelbezeichnung Article name	Glasdicke Glass thickness	Merkmale Features	VE/Stück pu/piece
8406	MS7	Duschtürpendelband, Glas-Wand, 90°, beidseitig 90° öffnend/ Shower swing door hinge, glass-wall, 90°, double sided opening 90°	8-10 mm	mit verstellbarer Nulllagenstellung, Langlochverstellung, einseitige Befestigungslasche/ with adjustable self-center, one sided mounting plate, adjustable along the oblong hole	1/2
	MS10				
	MSPVD22				

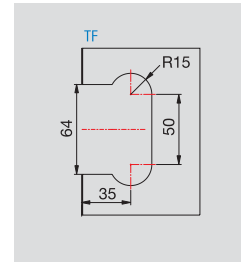
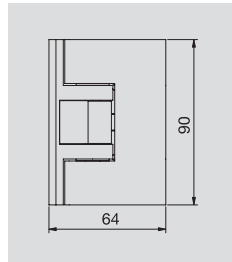
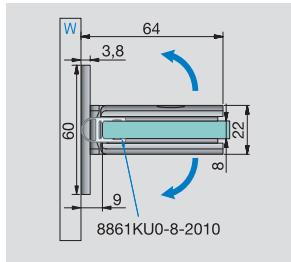

10

Artikel-Nr. Article-no.	Oberflächen Finishes	Artikelbezeichnung Article name	Glasdicke Glass thickness	Merkmale Features	VE/Stück pu/piece
8408	MS7	Duschtürpendelband, Glas-Wand, 90°, beidseitig 90° öffnend/ Shower swing door hinge, glass-wall, 90°, double sided opening 90°	8-10 mm	mit verstellbarer Nulllagenstellung, beidseitige Befestigungslasche/ with adjustable self-center, double sided mounting plate	1/2
	MS10				
	MSPVD22				

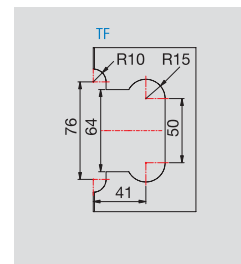
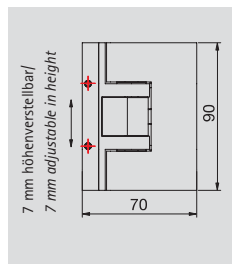
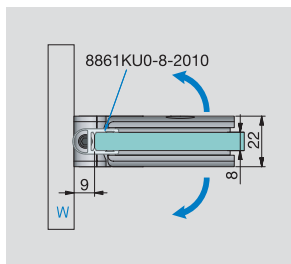

Artikel-Nr. Article-no.	Oberflächen Finishes	Artikelbezeichnung Article name	Glasdicke Glass thickness	Merkmale Features	VE/Stück pu/piece
8404	MS7	Duschtürpendelband, Glas-Wand, 90°, beidseitig 90° öffnend/ Shower swing door hinge, glass-wall, 90°, double sided opening 90°	8-10 mm	mit verstellbarer Nulllagenstellung, 7 mm höhenverstellbar/ with adjustable self-center, adjustable in height	1/2
	MS10				
	MSPVD22				

Die Glasbearbeitung für 10 mm Glas oder andere Spaltmaße erhalten Sie auf Anfrage!
Further details on 10 mm glass or other dimensions are available on request.

Pontere

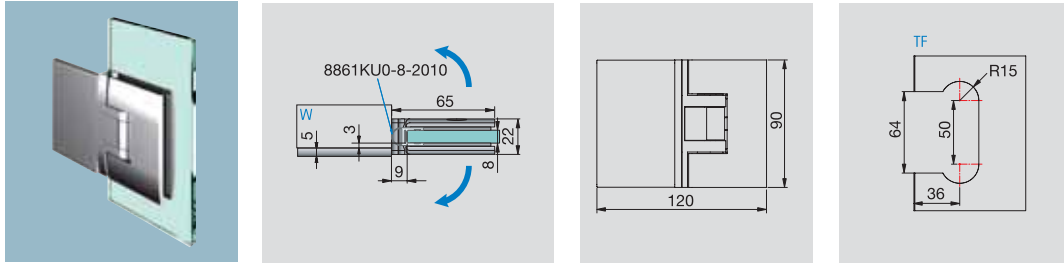

Artikel-Nr. Article-no.	Oberflächen Finishes	Artikelbezeichnung Article name	Glasdicke Glass thickness	Merkmale Features	VE/Stück pu/piece
8412	MS7	Duschtürpendelband, Glas-Wand, 180°, beidseitig 90° öffnend/ Shower swing door hinge, glass-wall, 180°, double sided opening 90°	8-10 mm	mit verstellbarer Nulllagenstellung, Langlochverstellung/ with adjustable self-center, adjustable along the oblong hole	1/2
	MS10				
	MSPVD22				

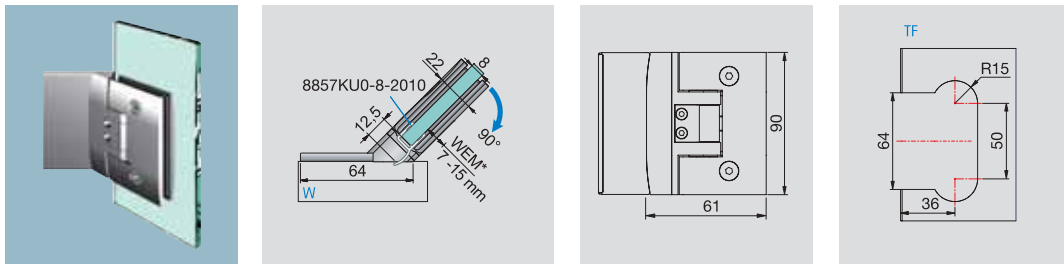

Artikel-Nr. Article-no.	Oberflächen Finishes	Artikelbezeichnung Article name	Glasdicke Glass thickness	Merkmale Features	VE/Stück pu/piece
8414	MS7	Duschtürpendelband, Glas-Wand, 135°, beidseitig 90° öffnend/ Shower swing door hinge, glass-wall, 135°, double sided opening outward 90°	8-10 mm	mit verstellbarer Nulllagenstellung, Langlochverstellung/ with adjustable self-center, adjustable along the oblong hole	1/2
	MS10				
	MSPVD22				

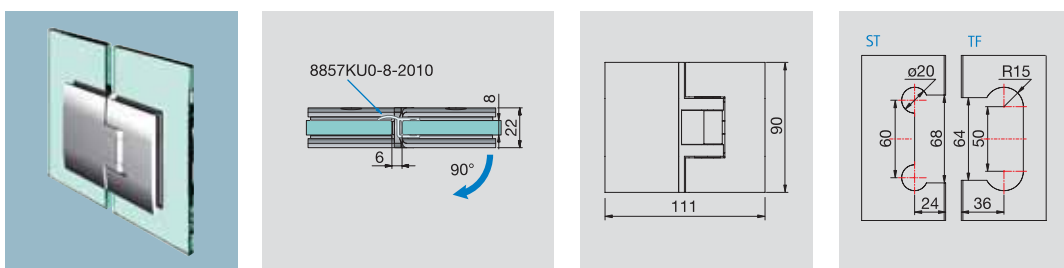

Artikel-Nr. Article-no.	Oberflächen Finishes	Artikelbezeichnung Article name	Glasdicke Glass thickness	Merkmale Features	VE/Stück pu/piece
8400	MS7	Duschtürpendelband, Glas-Glas, 180°, beidseitig 90° öffnend/ Shower swing door hinge, glass-glass, 180°, one sided opening outward 90°	8-10 mm	mit verstellbarer Nulllagenstellung, Langlochverstellung/ with adjustable self-center, adjustable along the oblong hole	1/2
	MS10				
	MSPVD22				

ST = Seitenteil/side panel
TF = Türflügel/ wing of the door
W = Wand/wall

*WEM= Wanneneinrückmaß/basin offset distance between the outer edge of the side panel and the outer edge of the shower basin

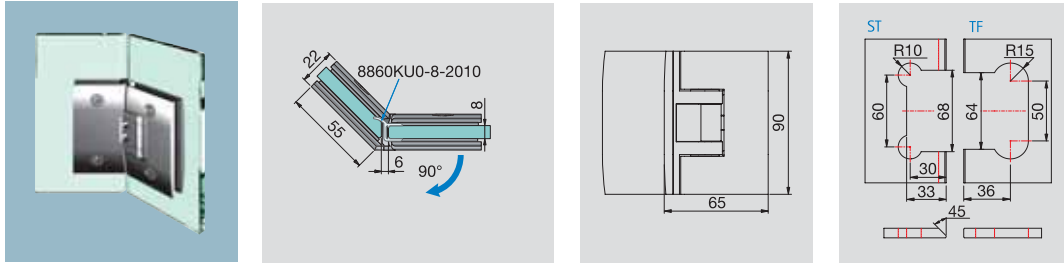
 Pontere

Artikel-Nr. Article-no.	Oberflächen Finishes	Artikelbezeichnung Article name	Glasdicke Glass thickness	Merkmale Features	VE/Stück pu/piece
8402	MS7	Duschtürpendelband, Glas-Glas, 135°, beidseitig 90° öffnend/ Shower swing door hinge, glass-glass, 135°, double sided opening outward 90°	8-10 mm	mit verstellbarer Nulllagene- llung/ with adjustable self-center, adjustable along the oblong hole	1/2
	MS10				
	MSPVD22				

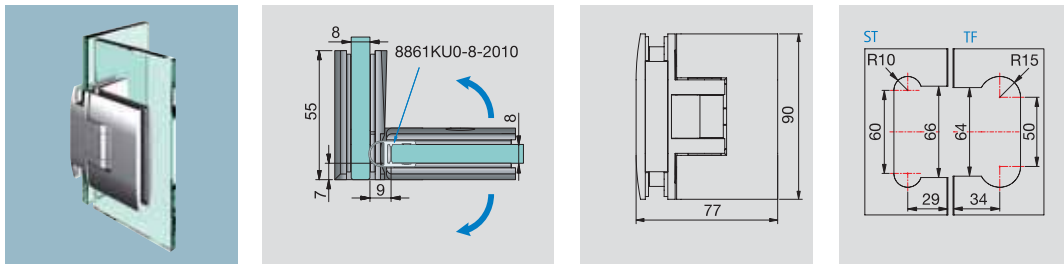

10

Artikel-Nr. Article-no.	Oberflächen Finishes	Artikelbezeichnung Article name	Glasdicke Glass thickness	Merkmale Features	VE/Stück pu/piece
8410	MS7	Duschtürpendelband, Glas-Glas, 90°, beidseitig 90° öffnend/ Shower swing door hinge, glass-glass, 90°, double sided opening 90°	8-10 mm	mit verstellbarer Nulllagene- llung/ with adjustable self-center, adjustable along the oblong hole	1/2
	MS10				
	MSPVD22				

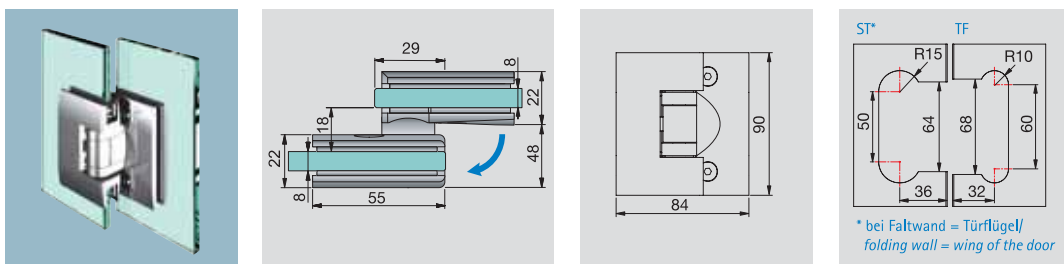

Artikel-Nr. Article-no.	Oberflächen Finishes	Artikelbezeichnung Article name	Glasdicke Glass thickness	Merkmale Features	VE/Stück pu/piece
8416	MS7	Duschtürpendelband, Glas-Glas, 180°, überlappend, einseitig 180° öffnend/ Shower swing door hinge, glass-glass, 180°, overlapping, one sided opening 180°	8-10 mm	mit verstellbarer Nulllagene- llung/ with adjustable self-center, adjustable along the oblong hole	1/2
	MS10				
	MSPVD22				

Beim Duschtürpendelband 8416 kann kein Dichtprofil eingepasst werden. Daher dienen die Glaselemente nur als Spritzschutz. Sollte die komplette Dichtigkeit der Dusche im Vordergrund stehen, empfehlen wir Ihnen unser Duschsystem Farfalla. / With this pendel shower door hinge 8416, no sealer profile can be fitted. The glass panels can only serve as a splash guard. For complete sealing of the shower we recommend our system Farfalla.

Pontere

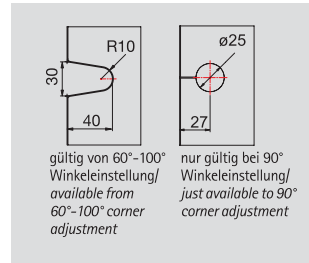
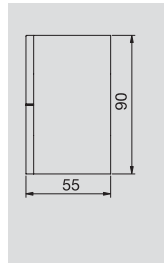
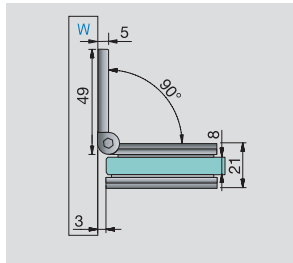
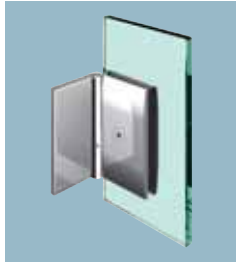

Artikel-Nr. Article-no.	Oberflächen Finishes	Artikelbezeichnung Article name	Glasdicke Glass thickness	Merkmale Features	VE/Stück pu/piece
8430	MS7	Winkelverbinder, Glas-Wand 90°/ corner bracket, glass-wall 90°	8-10 mm	Winkelgradzahl stufenlos von 60°-100° verstellbar, Langloch- verstellung/degree of angle is infinitely adjustable between 60°-100°, adjustable along the	1/2
	MS10				
	MSPVD22				

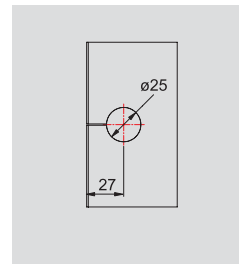
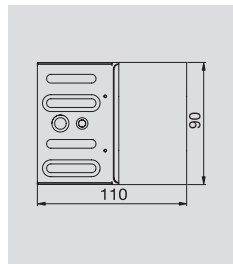
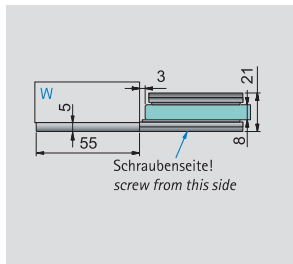
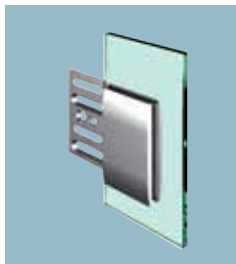

Artikel-Nr. Article-no.	Oberflächen Finishes	Artikelbezeichnung Article name	Glasdicke Glass thickness	Merkmale Features	VE/Stück pu/piece
8428	MS7	Längsverbinder, Glas-Wand 180°/ Inline connector, glass-wall 180°	8-10 mm	Langlochverstellung mit Abdeck- platte, Schraubenseite rechts und links verwendbar/and comes with cover plate, screw side usable left or right, adjustable along the oblong hole	1/2
	MS10				
	MSPVD22				

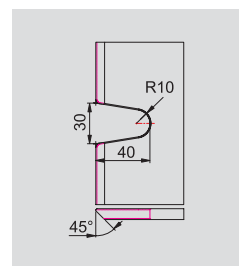
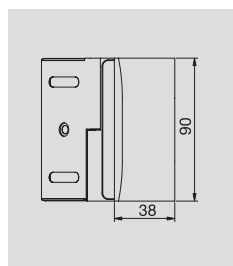
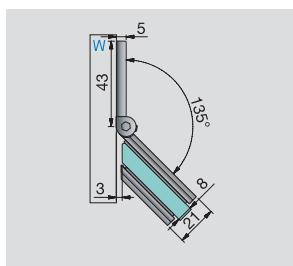
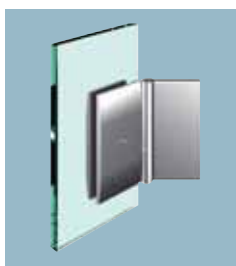

Artikel-Nr. Article-no.	Oberflächen Finishes	Artikelbezeichnung Article name	Glasdicke Glass thickness	Merkmale Features	VE/Stück pu/piece
8427	MS7	Winkelverbinder, Glas-Wand 135°/ corner bracket, glass-wall 135°	8-10 mm	Winkelgradzahl stufenlos von 120°-140° verstellbar, Langloch- verstellung/degree of angle is infinitely adjustable between 120°-140°, adjustable along the oblong hole	1/2
	MS10				
	MSPVD22				

Die Glasbearbeitung für 10 mm Glas oder andere Spaltmaße erhalten Sie auf Anfrage!
Further details on 10 mm glass or other dimensions are available on request.

ST = Seitenteil/side panel
TF = Türflügel/ wing of the door
W = Wand/wall

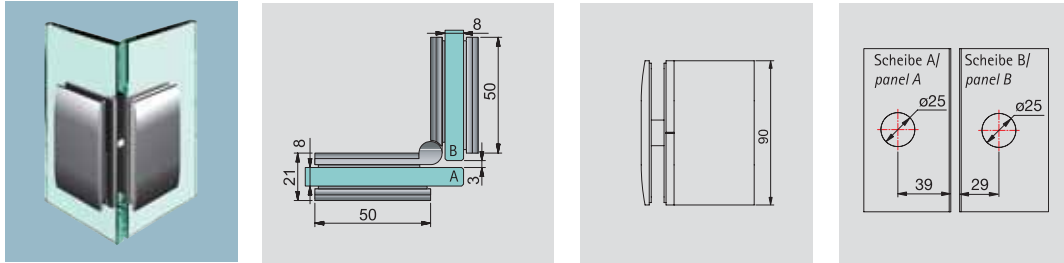
 Pontere

Artikel-Nr. Article-no.	Oberflächen Finishes	Artikelbezeichnung Article name	Glasdicke Glass thickness	Merkmale Features	VE/Stück pu/piece
8421	MS7	Winkelverbinder, Glas-Glas 90°/ corner bracket, glass-glass 90°	8-10 mm	Winkelgradzahl stufenlos von 80°-180° verstellbar/ degree of angle is infinitely adjustable between 80°-180°	1/2
	MS10				
	MSPVD22				

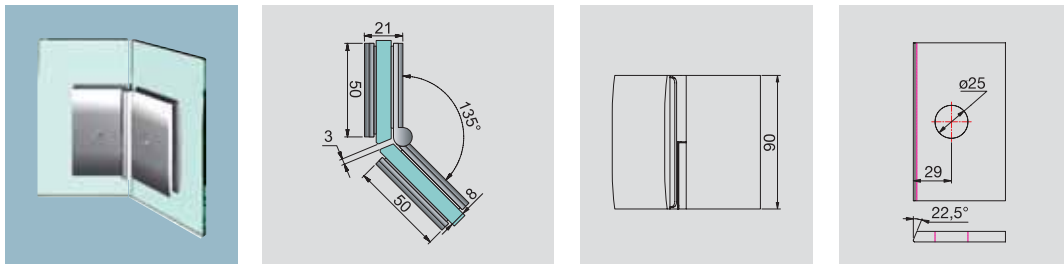

10

Artikel-Nr. Article-no.	Oberflächen Finishes	Artikelbezeichnung Article name	Glasdicke Glass thickness	Merkmale Features	VE/Stück pu/piece
8425	MS7	Winkelverbinder, Glas-Glas 135°/ corner bracket, glass-glass 135°	8-10 mm	Winkelgradzahl stufenlos von 80°-180° verstellbar/ degree of angle is infinitely adjustable between 80°-180°	1/2
	MS10				
	MSPVD22				

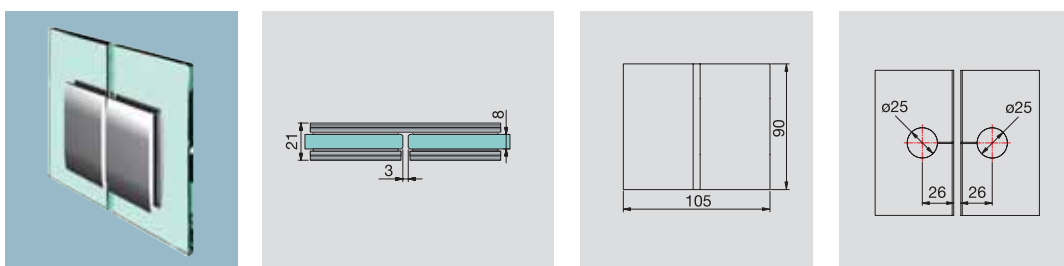

Artikel-Nr. Article-no.	Oberflächen Finishes	Artikelbezeichnung Article name	Glasdicke Glass thickness	Merkmale Features	VE/Stück pu/piece
8422	MS7	Längsverbinder, Glas-Glas 180°/ Inline connector, glass-glass 180°	8-10 mm	-	1/2
	MS10				
	MSPVD22				

Die Glasbearbeitung für 10 mm Glas oder andere Spaltmaße erhalten Sie auf Anfrage!
Further details on 10 mm glass or other dimensions are available on request.

 **Pontere**

ST = Seitenteil/*side panel*
TF = Türflügel/*wing of the door*
W = Wand/*wall*

Farben/colours

MS7 poliert verchromt/*brass polished finish*



MS10 Messing mattverchromt/*brass matt chrome finish*



MSPVD22 edelstahlfinish PVD-beschichtet/*stainless steel finish PVD coated*

● Pontere

Technische Informationen für Anwendungsbeispiele/
technical information for applications example



Pontere



10

Set 1-103

Eckduschen Set bestehend aus/
corner shower set comprised of:



4 x 8406MS



1 x 8863KU0-8-2010



2 x 8297MS-50

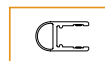

2 x 8861KU0-8-2010



1 x 8856KU0-8-2010



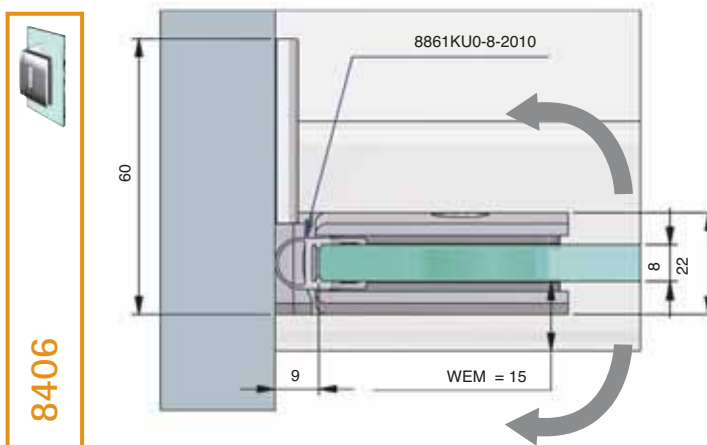



Türflügel beidseitig 90° öffnend/wing of the door
opens in both direction 90°



WEM = Wanneneinrückmaß/ basin offset distance between the outer edge of the side panel and the outer edge of the shower basin

Pontere



Set 1-202			
Eckduschen Set bestehend aus/ corner shower set comprised of:			
	2 x 8406MS		1 x 8861KU0-8-2010
	2 x 8421MS		1 x 8856KU0-8-2010
	2 x 8430MS		1 x 8863KU0-8-2010
	1 x 8297MS-50		

Türflügel einseitig 90° öffnend/wing of the door
opens in one direction 90°

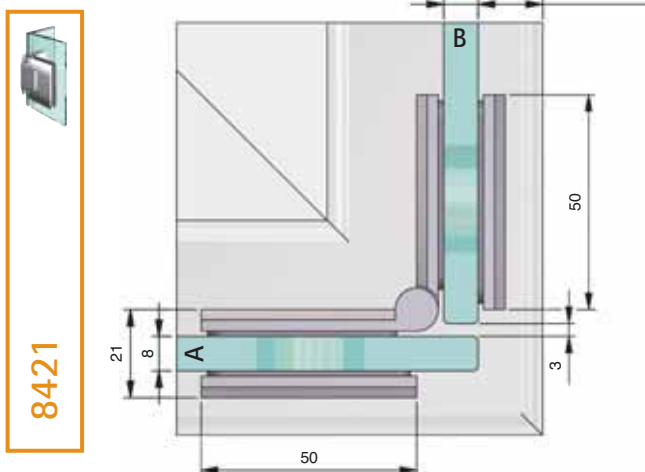

WEM = Wanneneinrückmaß/ basin offset distance between the outer edge of the side panel and the outer edge of the shower basin

● Pontere



10

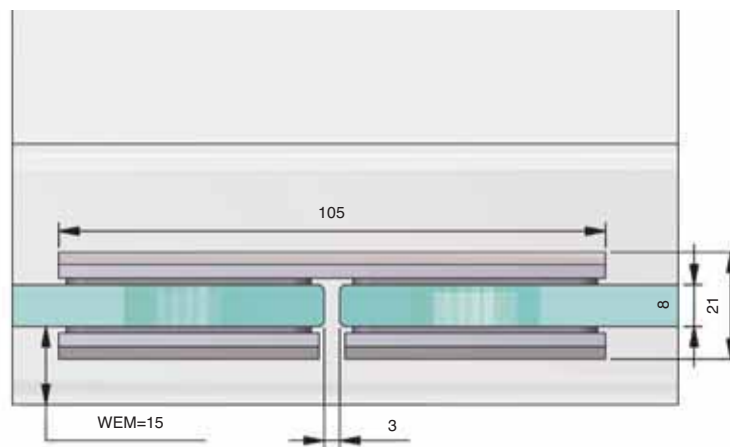

WEM = Wanneneinrückmaß| basin offset distance between the outer edge of the side panel and the outer edge of the shower basin

Pontere



Set 1-209			
Eckduschen Set bestehend aus/ corner shower set comprised of:			
	4 x 8430MS		1 x 8851KU0-8-2010
	4 x 8400MS		1 x 8863KU0-8-2010
	2 x 8297MS-50		
	2 x 8857KU0-8-2010		

Türflügel einseitig 90° öffnend/ wing of the door opens in one direction 90°

10

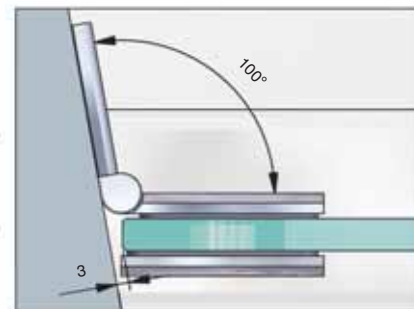
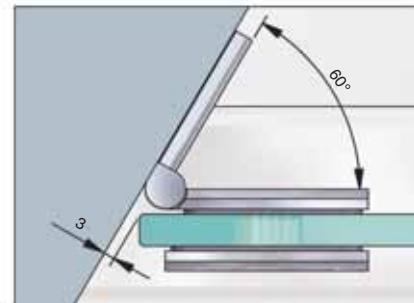
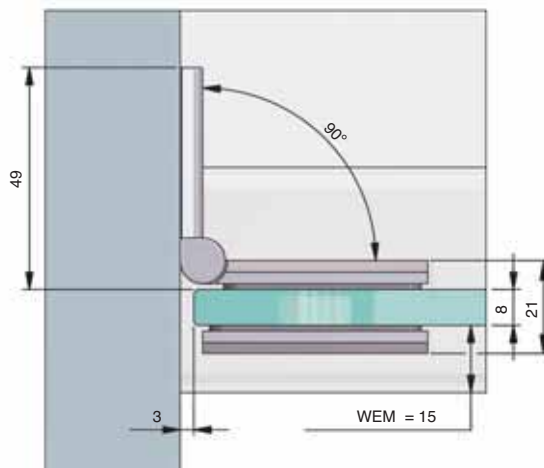







Gradzahl stufenlos von 60° - 100° verstellbar/ Degree of angle is infinitely adjustable between 60° and 100°
 WEM = Wanneneinrückmaß/ basin offset distance between the outer edge of the side panel and the outer edge of the shower basin

Pontere



10

Set 1-210			
Eckduschen Set bestehend aus/ corner shower set comprised of:			
	4 x 8430MS		1 x 8857KU0-8-2010
	2 x 8400MS		1 x 8855KU0-8-2010
	1 x 8297MS-50		1 x 8863KU0-8-2010
	1 x 8432MS-860		

Türflügel einseitig 90° öffnend/ wing of the door
opens in one direction 90°

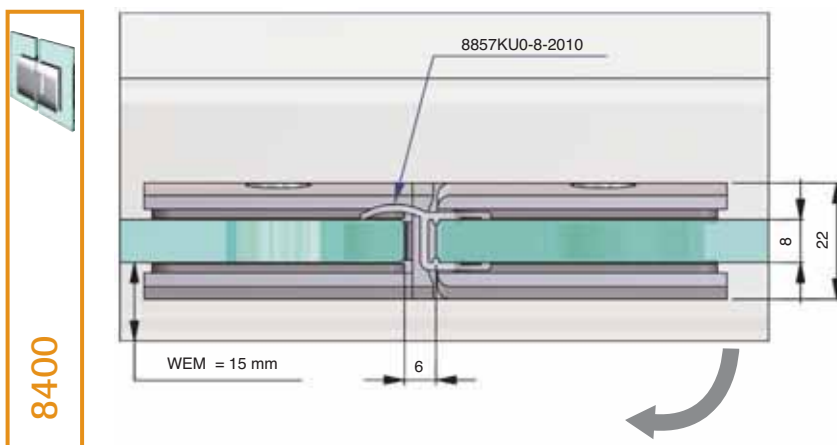

WEM = Wanneneinrückmaß/ basin offset distance between the outer edge of the side panel and the outer edge of the shower basin

Pontere



Türflügel einseitig 90° öffnend/ wing of the door opens in one direction 90°

Set 1-219			
Eckduschen Set bestehend aus/ corner shower set comprised of:			
	2 x 8430MS		1 x 8861KU0-8-2010
	2 x 8400MS		1 x 8857KU0-8-2010
	2 x 8412MS		1 x 8851KU0-8-2010
	2 x 8297MS-50		1 x 8863KU0-8-2010



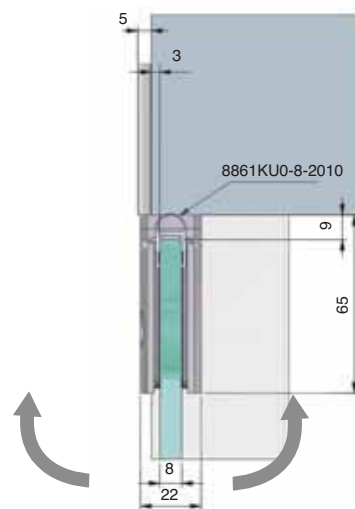
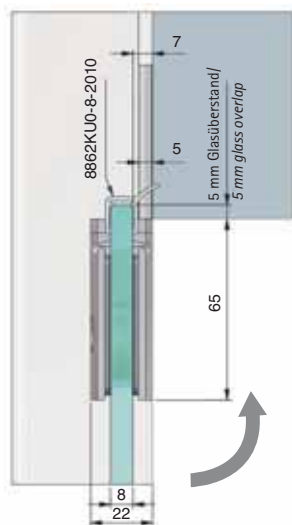



Türflügel beidseitig 90° öffnend/wing of the door opens in both direction 90°



● Pontere



10

Set 1-221			
Eckduschen Set bestehend aus/ corner shower set comprised of:			
	2 x 8406MS		1 x 8861KU0-8-2010
	2 x 8421MS		1 x 8856KU0-8-2010
	2 x 8428MS		1 x 8863KU0-8-2010
	1 x 8297MS-50		

Türflügel einseitig 90° öffnend/wing of the door
opens in one direction 90°

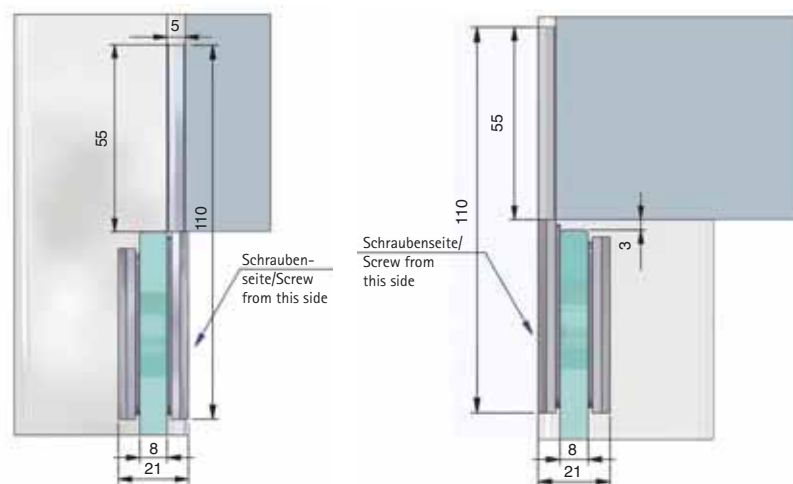

WEM = Wanneneinrückmaß/ basin offset distance between the outer edge of the side panel and the outer edge of the shower basin

● Pontere



Set 1-304			
5-Eckduschen Set bestehend aus/ 5-corner shower set comprised of:			
	4 x 8427MS		1 x 8853KU0-8-2010
	2 x 8402MS		1 x 8860KU0-8-2010
	1 x 8297MS-50		1 x 8863KU0-8-2010
	1 x 8434MS-710		

Türflügel einseitig 90° öffnend/wing of the door
opens in one direction 90°

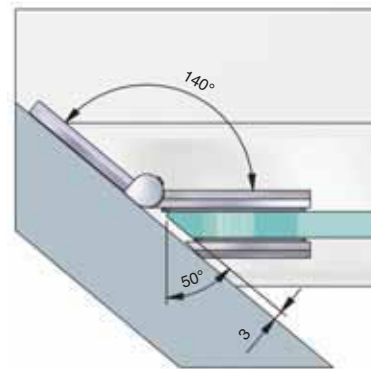

10

8427

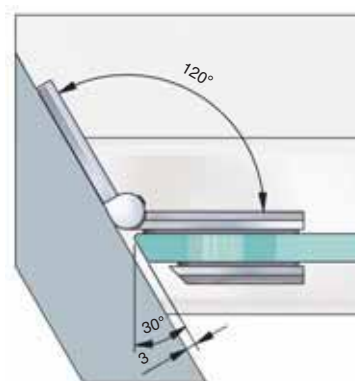
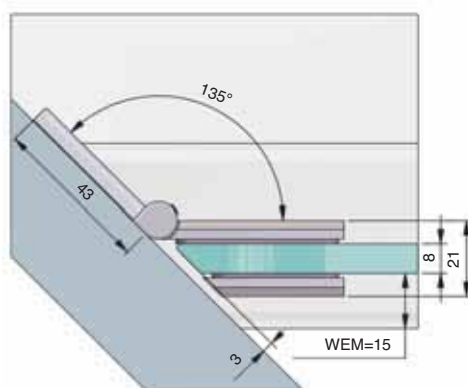



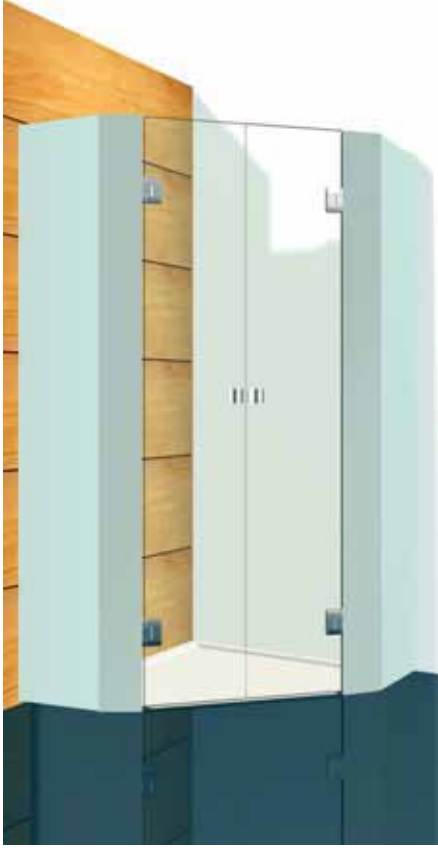

Gradzahl stufenlos von 120° - 140° verstellbar/ degree of angle is infinitely adjustable between 120° and 140°.
WEM = Wanneneinrückmaß/ basin offset distance between the outer edge of the side panel and the outer edge of the shower basin

Pontere



10

Türflügel beidseitig 90° öffnend/wing of the door opens in both direction 90°

Set 1-306	
5-Eckduschen Set bestehend aus/ 5-corner shower set comprised of:	
	4 x 8404MS
	2 x 8297MS-50
	1 x 8852KU0-8-2010
	2 x 8861KU0-8-2010
	1 x 8863KU0-8-2010

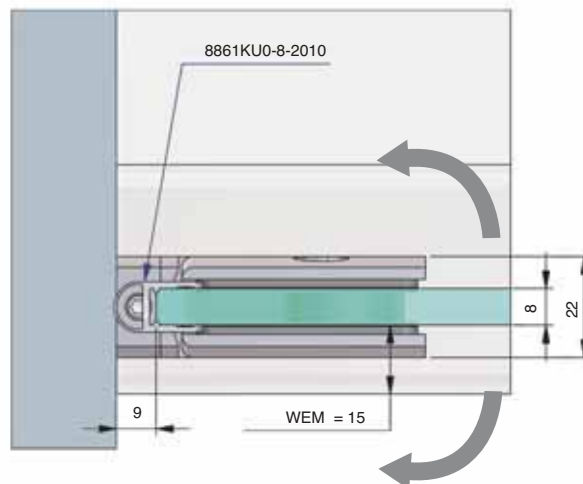
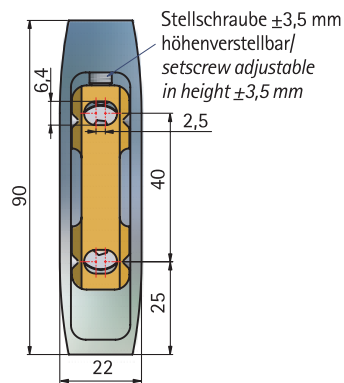

WEM = Wanneneinrückmaß/ basin offset distance between the outer edge of the side panel and the outer edge of the shower basin

Pontere



Set 1-309			
5-Eckduschen Set bestehend aus/ 5-corner shower set comprised of:			
	2 x 8406MS		1 x 8857KU0-8-2010
	2 x 8414MS		2 x 8853KU0-8-2010
	2 x 8297MS-50		1 x 8863KU0-8-2010
	1 x 8861KU0-8-2010		

Türflügel einseitig 90° öffnend/ wing of the door opens in one direction 90°

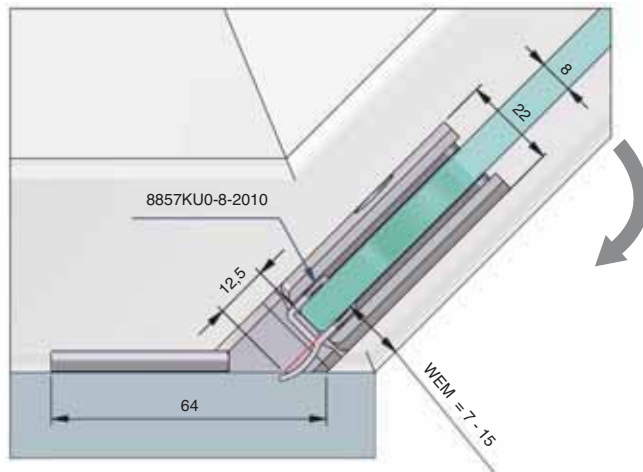

WEM = Wanneneinrückmaß/ basin offset distance between the outer edge of the side panel and the outer edge of the shower basin

Pontere











10

Türflügel einseitig 90° öffnend/wing of the door opens in one direction 90°

Set 1-310

5-Eckduschen Set bestehend aus/
5-corner shower set comprised of:

	2 x 8406MS		1 x 8432MS-730
	2 x 8425MS		1 x 8861KU0-8-2010
	2 x 8430MS		1 x 8853KU0-8-2010
	1 x 8297MS-50		1 x 8863KU0-8-2010

8425

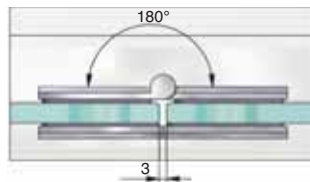
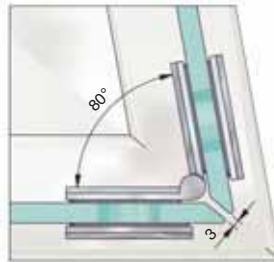
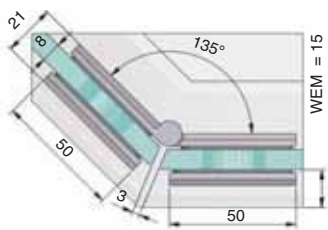









Winkel/corner	Maß Mitte Bohrung bis Glaskante/dimension middle of bore to glass edge	Gehrungswinkel am Glas/miter angle at glass
80°	38 mm	50°
85°	37 mm	47,5°
90°	36 mm	45°
95°	35 mm	42,5°
100°	34 mm	40°
105°	33 mm	37,5°
110°	32 mm	35°
115°	31 mm	32,5°
120°	31 mm	30°
125°	30 mm	27,5°
130°	29 mm	25°
135°	29 mm	22,5°
140°	28 mm	20°
145°	27 mm	17,5°
150°	27 mm	15°
155°	26 mm	12,5°
160°	26 mm	10°
165°	25 mm	7,5°
170°	25 mm	5°
175°	24 mm	ohne
180°	24 mm	ohne

Bohrung geschlitzt/
bore hole slotted

Gradzahl stufenlos von 80° - 180° verstellbar/ degree of angle is infinitely adjustable between 80° and 180°,
WEM = Wanneneinrückmaß/ basin offset distance between the outer edge of the side panel and the outer edge of the shower basin

Pontere



Set 1-313			
5-Eckduschen Set bestehend aus/ 5-corner shower set comprised of:			
	4 x 8430MS		1 x 8434MS-840
	4 x 8402MS		1 x 8856KU0-8-2010
	2 x 8421MS		2 x 8860KU0-8-2010
	2 x 8297MS-50		1 x 8863KU0-8-2010

Türflügel einseitig 90° öffnend/ wing of the door opens in one direction 90°

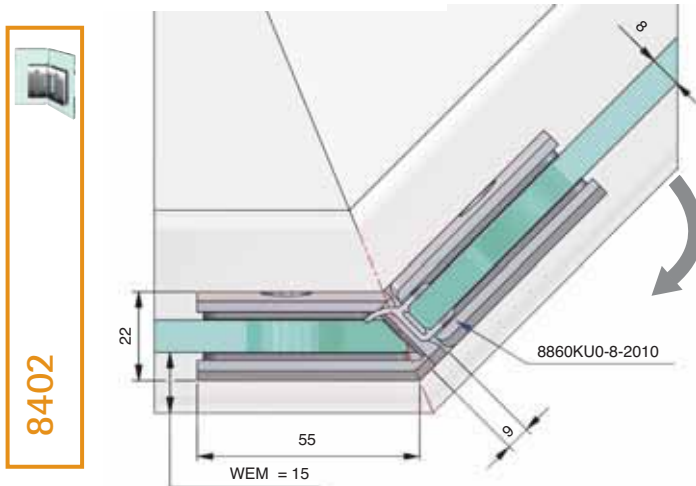

WEM = Wanneneinrückmaß/ basin offset distance between the outer edge of the side panel and the outer edge of the shower basin







● Pontere



10

Set 1-402

U-Duschen Set bestehend aus/
U-corner shower set comprised of:

	4 x 8430MS		2 x 8861KU0-8-2010
	4 x 8410MS		1 x 8856KU0-8-2010
	2 x 8297MS-50		1 x 8863KU0-8-2010
	1 x 8434MS-840		



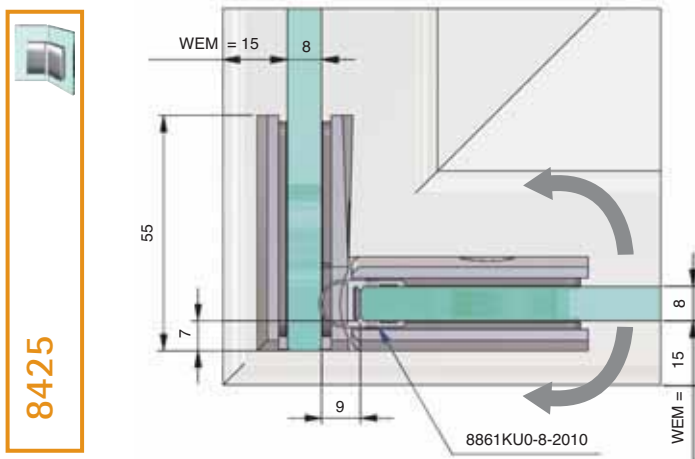

Türflügel beidseitig 90° öffnend/ wing of the door
opens in both direction 90°



WEM = Wanneneinrückmaß/ basin offset distance between the outer edge of the side panel and the outer edge of the shower basin

Pontere



Set 1-611			
Eckduschen Set bestehend aus/ corner shower set comprised of:			
	4 x 8406MS		1 x 8863KU0-8-2010
	2 x 8297MS-50		
	2 x 8861KU0-8-2010		
	1 x 8851KU0-8-2010		

Türflügel einseitig 90° öffnend/wing of the door opens
in one direction 90°

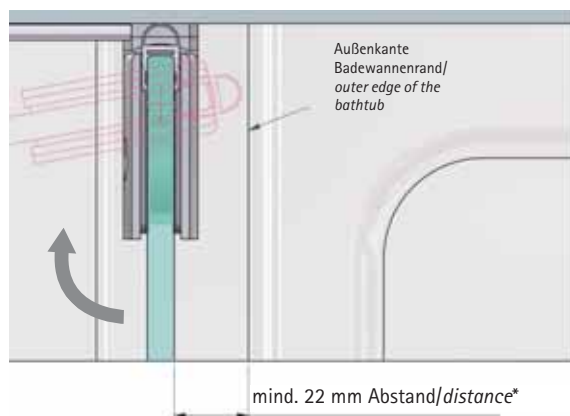

* zwischen Wanne und Außenkante Glas, da
dadurch das Schwenkmaß beim Öffnen des
Türflügels berücksichtigt wird!
A minimum of 22 mm distance between the
bathtub and outer edge of glass is to be
maintained.. The radius during opening of
door wing must be considered!