

MUTO Comfort L80

Montageanleitung

Notice de pose

Mounting instructions

Istruzioni per il montaggio



Instrucciones de montaje





Инструкция по монтажу

WN 059426 45532/15150 – 2020-07

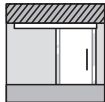
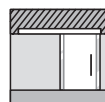
DE | EN | ES
FR | IT | RU

dormakaba 

	<p>Allgemeine Informationen über Anleitung und Produkt (DE) General information about the instructions and the product (EN) Información general del producto e instrucciones de montaje (ES) Informations générales sur les instructions de montage et le produit (FR) Informazioni generali relative alle istruzioni di prodotto (IT) Общая информация о продукте и настоящем руководстве (RU)</p>	<p>4-5 6-7 8-9 10-11 12-13 14-15</p>
	<p>Lieferumfang (DE) Scope of delivery (EN) Volumen de suministro (ES) Étendue de la livraison (FR) Dotazione (IT) Комплект поставки (RU)</p>	16
	<p>Wandmontage (DE) Wall mounting (EN) Montaje en la pared (ES) Pose murale (FR) Montaggio a parete (IT) Крепление к стене (RU)</p>	17-30
	<p>Montage ohne DORMOTION (DE) Installation without DORMOTION (EN) Montaje sin DORMOTION (ES) Variante sans DORMOTION (FR) Variante senza DORMOTION (IT) Без функции DORMOTION (RU)</p>	31
	<p>Ausführungsvariante an Decke (DE) Version at ceiling (EN) Montaje a techo (ES) Variante au plafond (FR) Versione a soffitto (IT) Крепление к потолку (RU)</p>	32-33
	<p>Ausführungsvariante in Deckenschlitz (DE) Version in ceiling slot (EN) Diseño en el hueco del techo (ES) Conception intégrée à la fente du plafond (FR) Realizzazione nella fessura della copertura (IT) Исполнение в прорези крышки (RU)</p>	34-35

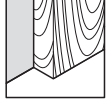
	<p>Ausführungsvariante mit einem Seitenteil (DE) Ausführungsvariante zwischen zwei Wänden/in Laibung (DE) Version with side panel (EN) Version between two walls/in a door jamb (EN) Variante de ejecución vidrio lateral (ES) Montaje entre dos paredes / fijado al marco de puerta (ES) Variante avec fixe latéral (FR) Variante entre deux murs / sous linteau (FR) Variante di montaggio con elemento affiancato (IT) Versione chiusura vano murario (IT) Вариант комплектации с боковой панелью (RU) Крепление в проём (RU)</p>	36-40
	<p>Ausführungsvariante mit zwei Seitenteilen und Sichtschutzprofil (DE) Version with two side panels and view protection profile (EN) Montaje con dos fijos laterales con perfil de protección visual (ES) Variante avec deux fixes latéraux et profilé d'occultation (FR) Versione con due pannelli laterali e profile di protezione (IT) Вариант комплектации с двумя боковыми панелями и декоративным профилем (RU)</p>	41-43
	<p>Ausführungsvariante für abgehängte Decke (DE) Version for false ceiling (EN) Montaje en falso techo (ES) Variante pour plafond suspendu (FR) Versione per controsoffitto (IT) Вариант комплектации для стыковки с фальш-потолком (RU)</p>	44-45
	<p>Ausführungsvariante an Glaswand (DE) Version on glass wall (EN) Variante de ejecución en frente de vidrio (ES) Variante sur cloison en verre (FR) Variante di esecuzione su parete in vetro (IT) Вариант комплектации для установки на стекло (RU)</p>	46-47
	<p>Ausführungsvariante Holztürflügel (DE) Version with wood panel door (EN) Variante de ejecución para puerta de madera (ES) Variante avec vantail bois (FR) Variante del modello per anta in legno (IT) Вариант комплектации с деревянной панелью (RU)</p>	48-49



ORIGINALANLEITUNG
VOR GEBRAUCH SORGFÄLTIG LESEN
AUFBEWAHREN FÜR SPÄTERES
NACHSCHLAGEN

Funktionsweise dieser Anleitung

Die Montage jeder Ausführungsvariante (z. B. Wand, Decke, mit Seitenteil) ist separat beschrieben. Montieren Sie die Anlage wie in dem entsprechenden Kapitel der Anleitung beschrieben.

Über diese Anleitung

Diese Anleitung beschreibt die Montage des Schiebetürsystems MUTO Comfort L 80 mit DORMOTION. Die Montage wird am Beispiel einer linksöffnenden Tür gezeigt. Die Montage für rechtsöffnende Türen erfolgt entsprechend spiegelbildlich.

Zielgruppe

DORMA-Glasbeschläge dürfen nur von Fachpersonal montiert werden.

Verwendete Symbole – Sicherheit**Vorsicht!**

Befestigungsmaterial muss den Anforderungen von Unterkonstruktion/Wand und Türflügelgewicht entsprechen. Beachten Sie die technischen Hinweise des Befestigungsmaterials.

**Vorsicht Glasbruch**

Bei Einhängen des Türflügels müssen Holzklötze oder ähnliches untergelegt werden.

**Vorsicht Verletzung durch Quetschen!**

Fangpuffer so positionieren, dass Türgriffe (Option) mindestens 25 mm Abstand zur Wand einhalten.



Nur silikon- und ölfreie Reiniger verwenden (z. B. Aceton).

Verwendete Symbole – Montage

Texthinweis beachten



Verweis auf Montageschritte für Ausführungsvarianten (Beispiel zeigt: Holzflügel, Schritt 2)



Zweiflügelige Schiebetür



Reihenfolge der Montageschritte



Einzelschritte innerhalb eines Montageschrittes



Schließkante

Sicherheitshinweise

- Montage muss von zwei Personen ausgeführt werden
- Schutzkleidung tragen

**Bestimmungsgemäße Verwendung**

- nur für Schiebetüren im trockenen Innenbereich
- nur für manuelles langsames Öffnen und Schließen

Anforderung Wand/Decke und Befestigungsmaterial

- Die Unterkonstruktion/Wand muss dauerhaft tragfähig, plan und lotrecht sein (max. Toleranz: 2 mm pro Meter).
- Das Befestigungsmaterial muss für die Unterkonstruktion / Wand geeignet und für das Türflügelgewicht ausreichend dimensioniert sein. Beachten Sie die technischen Hinweise des Befestigungsmaterials.
- Befestigungsmaterial ist nicht im Lieferumfang enthalten.

Anforderungen Glastürflügel:

- heißgelagertes Einscheibensicherheitsglas (ESG-H nach DIN EN 12150-1)
- Klembereich muss plan und unbeschichtet sein (keine selbstreinigenden Beschichtungen!)

Wartung, Pflege, Reparatur

- mind. 5 Jahre wartungsfreier Betrieb (bei 50 Betätigungen pro Tag)
- beschädigte Bauteile unverzüglich austauschen
- nur DORMA-Originalteile verwenden
- gelegentliche Reinigung, insbesondere der Lauffläche, nur mit feuchtem Tuch

Entsorgung

Die ordnungsgemäße Entsorgung unterliegt den geltenden nationalen gesetzlichen Vorschriften.

Lieferumfang



- 1 Abdeckprofil
- 2 Sichtschutzbürste (in zwei Ausführungen)
- 3 Glaskantenschutz bei Anschlag Türflügel-Wand oder Türflügel-Türflügel



- 4 Bodenführungsset für Glastürflügel mit Einstellmöglichkeit der Glasführung
- 5 DORMOTION-Einheiten - optional
- 6 Rollenwagen
- 7 DORMOTION-Starter - optional
- 8 Haltereinsatz für Abdeckprofil
- 9 Laufschiene
- 10 Fangpuffer zur Begrenzung des Anschlags Türflügels beim Öffnen und Schließen
- 11 Endkappe



- 12 Taschenprofil
- 13 Haltereinsatz Pocket door
- 14 Abdeckprofil
- 15 Profilverbinder



- 16 Abstandshalter für Abdeckprofil
- 17 Stirnabdeckung
- 18 Seitenteilprofil
- 19 Verglasungsdichtung (in drei Ausführungen)
- 20 Zwischenlage
- 21 Füllprofil
- 22 Glasanlageprofil
- 23 Glasaufnahme Boden



- 24 Sichtschutzprofil
- 25 Halterclips



- 26 Profil für abgehängte Decke





- 27 Stirnabdeckung
- 28 Gegenhalteprofil
- 29 Halteplatten



- 30 Holzadapter für Rollenwagen
- 31 Bodenführungsset für Holztürflügel

Technische Daten

		
	2000	2x 1250
max. Türflügelbreite [mm]	8-13,5	8-13,5
Türflügelglasdicke [mm]	< 80	2x < 80
Türflügelgewicht [kg]	10-19	10-19
Glasdicke Festverglasung [mm]	8-13,5	8-13,5
Glasseitenteildicke		
	2000	2x 1250
max. Türflügelbreite [mm]	28-50	28-50
Holzflügeldicke [mm]	< 80	2x < 80
Türflügelgewicht [kg]		

Subject to change without notice



ORIGINAL INSTRUCTIONS
READ CAREFULLY BEFORE USE
KEEP SAFE FOR
FUTURE REFERENCE

Functionality of this manual

The mounting of each different version (e.g. wall, ceiling, with side panel) is described separately. Mount the system as described in the respective chapter of your manual.

Regarding these instructions

These instructions describe the mounting of the sliding door system MUTO Comfort L 80 with DORMOTION. These instructions describe the installation of a left hand door. Use mirror image for a right hand door.

Target group

Only properly qualified staff is authorized to mount DORMA glass fittings.

Symbols used – Safety



Caution!

Fittings must meet the requirements of substructure/wall and door weight. Please read the technical information for fittings.



Risk of breaking glass

When fitting the door, support the panel with a block of wood or similar object.



Risk of crushing!

Position buffer stop so door handles (optional) are at least 25 mm away from the wall.



Always use silicone- and oil-free cleaners (e.g. acetone).

Symbols used – Installation



Read notes



Reference to deviating installation steps for different versions (Example here: wood panel, step 2)



Two-leaf sliding door



Installation sequence



Individual steps within an installation step
Closing edge



Closing edge

Safety instructions

- Installation requires two people
- Always wear protective clothing



Intended use

- for sliding doors in dry indoor areas only
- for manual slow opening and closing only, door leaf must be stopped manually before reaching end position

Wall/Ceiling requirements and fittings

- The substructure/wall must be able to bear permanent loads, be level and perpendicular (max. tolerance: 2 mm per meter).
- Fittings must be sufficiently dimensioned for the substructure/wall and for the weight of the door. Please read the technical information for fittings.
- Fittings are not included.

Requirements for glass panel:

- Heat-soaked thermally toughened safety glass (ESG-H in compliance with DIN EN 12150-1)
- Clamping area must be level and uncoated (no self-cleaning coating!)

Maintenance, care, repair

- minimum of 5 years maintenance-free operation (based on 50 cycles per day)
- immediately replace damaged parts
- always use original DORMA parts
- use a damp cloth for occasional cleaning especially of the track

Disposal

Dispose in accordance with national regulations.

Scope of delivery



- 1 Cover panel
- 2 Brush strip (in two versions)
- 3 Glass edge protector for door leaf/wall or door leaf/door leaf end stop



- 4 Floor guide kit for glass door leaf with glass guide adjustment option
- 5 DORMOTION unit - optional
- 6 Roller carriage
- 7 DORMOTION starter - optional
- 8 Bracket insert for cover panel
- 9 Track
- 10 Buffer stop to limit door travel when opening and closing
- 11 End cap



- 12 Pocket profile
- 13 Pocket door holder insert
- 14 Cover panel
- 15 Profile connector



- 16 Cover spacer
- 17 End cover
- 18 Side section panel
- 19 Glazing seal (in three versions)
- 20 Pad
- 21 Filler panel
- 22 Glass connecting pad
- 23 Bottom glass slot



- 24 View Protection Profile
- 25 Retaining Clips



- 26 Connecting profile for false ceiling





- 27 End cover
- 28 Counter panel
- 29 Retaining plates



- 30 Wood adapter for roller carriage
- 31 Floor guide kit for wooden door leaf

Technical data

			
	Max. door leaf width [mm]	2000	2x 1250
	Door leaf glass thickness [mm]	8-13.5	8-13.5
	Door leaf weight [kg]	< 80	2x < 80
	Glass thickness fixed glazing [mm]	10-19	10-19
	Glass side panel thickness	8-13.5	8-13.5
	Max. door leaf width [mm]	2000	2x 1250
	Wood leaf thickness [mm]	28-50	28-50
	Door leaf weight [kg]	< 80	2x < 80



Traducción de las instrucciones originales
LEER ATENTAMENTE ANTES DE USAR
CONSERVAR PARA CONSULTAS
POSTERIORES

Funcionalidad de este manual

El montaje para cada versión es diferente (ejemp. pared, techo con vidrio lateral) y se describen por separado. Por favor monte el sistema como se describe en el capítulo correspondiente del manual.

Acerca de estas instrucciones

Estas instrucciones describen el montaje del sistema de puerta corredera MUTO Comfort L 80 con DORMOTION. Estas instrucciones describen la instalación de una puerta de mano izquierda.

Grupo designado

El montaje de los herrajes de vidrio debe llevarlo a cabo personal cualificado y que esté especialmente formado para instalar vidrios.

Símbolos utilizados. Seguridad



¡Atención!

El material de fijación debe cumplir los requerimientos de la subestructura/pared y del peso de las hojas de la puerta. Observe las indicaciones técnicas del material de fijación.



¡Atención! ¡Riesgo de rotura de vidrios!

Al colgar la hoja de la puerta se deben colocar debajo tacos de madera u otros objetos similares.



¡Atención! ¡Lesiones por aplastamiento!

Posicionar el amortiguador de modo que los tiradores de la puerta (opcionales) queden a una distancia mínima de 25 mm de la pared.



Usar únicamente limpiadores sin silicona ni aceite (p. ej. acetona).

Símbolos utilizados. Montaje



Observar las notas



Referencia sobre pasos de montaje distintos para variantes de ejecución (en el ejemplo: hoja de madera, paso 2)

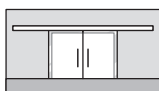

Puerta corredera de dos hojas



Orden de los pasos de montaje



Pasos individuales dentro de un paso de montaje



Canto de cierre

Indicaciones de seguridad

- El montaje debe ser realizado por dos personas.
- Llevar ropa de protección



Uso conforme a lo previsto

- Solo para puertas correderas en interiores secos.
- Solo para abrir y cerrar lentamente a mano; la hoja de la puerta se debe detener a mano antes de alcanzar la posición final.

Requerimiento de la pared/el techo y material de fijación

- La subestructura/pared debe contar con capacidad de carga permanente y ser plana y perpendicular (tolerancia máx.: 2 mm por metro).
- El material de fijación debe ser adecuado para la subestructura/pared, y estar suficientemente dimensionado para el peso de las hojas de la puerta. Observe las indicaciones técnicas del material de fijación.
- El material de fijación no está incluido.

Requerimientos de las puerta de vidrio:

- Vidrio de seguridad monocapa templado (ESG-H según DIN EN 12150-1).
- La zona de sujeción debe ser plana y sin revestir (¡sin revestimientos autolimpiantes!).

Mantenimiento, cuidado y reparación

- Funcionamiento libre de mantenimiento durante al menos 5 años (con 50 accionamientos al día).
- Sustituir de inmediato los componentes dañados.
- Usar únicamente piezas originales de DORMA.
- Limpieza ocasional, en particular de la superficie de deslizamiento, solo con un paño húmedo.

Disposición

La eliminación o cambio de las normas está sujeta a los requisitos legales en vigor de cada país.

Volumen de suministro



- 1 Perfil tapa
- 2 Cepillo de protección visual
- 3 (en dos ejecuciones)
- 4 Protección de canto del vidrio (tope puerta-pared o puerta-puerta)
- 5 Guía de suelo "regulable" para puerta de vidrio
- 6 Unidad DORMOTION - Opcional
- 7 Patín de rodillos
- 8 Iniciador DORMOTION - Opcional
- 9 Soporte para perfil tapa
- 10 Carril guía deslizante
- 11 Amortiguador para limitar el tope de la hoja de la puerta durante la apertura y el cierre
- 12 Tapa lateral



- 13 Perfil de puerta corrediza
- 14 Inserción del soporte de la puerta corrediza
- 15 Perfil tapa
- 16 Conectores del perfil



- 16 Separadores tapa
- 17 Cubierta frontal
- 18 Perfil de lateral
- 19 Junta de acristalamiento (en tres ejecuciones)
- 20 Pieza intermedia
- 21 Perfil de relleno
- 22 Perfil de colocación del vidrio
- 23 Alojamiento de vidrio en suelo



- 24 Perfil de protección visual
- 25 Clips de sujeción



- 26 Perfil de conexión para falso techo





- 27 Cubierta frontal
- 28 Contraperfil
- 29 Placas de retención



- 30 Adaptador para madera, para patín de rodillos
- 31 Guía de suelo para puerta de madera

Especificaciones técnicas

			
	Máx. anchura hoja de puerta [mm]	2000	2x 1250
	Espesor puerta de vidrio [mm]	8-13,5	8-13,5
	Peso hoja de puerta [kg]	< 80	2x < 80
	Espesor del vidrio fijo [mm]	10-19	10-19
	Espesor del vidrio lateral	8-13,5	8-13,5
	Máx. anchura hoja de puerta [mm]	2000	2x 1250
	Espesor puerta de madera [mm]	28-50	28-50
	Peso hoja de puerta [kg]	< 80	2x < 80



Traduction de la notice originale
À LIRE AVEC SOIN AVANT UTILISATION
À CONSERVER POUR
CONSULTATION ULTÉRIEURE

FR

Utilisation de ce manuel de montage

Le montage de chaque version est décrit séparément (par ex. mur, plafond, avec fixe-latéral). Montez le système tel que décrit au chapitre correspondant du manuel.

A propos de ce manuel de montage

Ces notices de montage concernent l'installation de MUTO Comfort L 80 avec Dormotion. L'ensemble est illustré par l'exemple d'une porte ouvrant à gauche. Le montage pour une porte ouvrant à droite est la copie miroir.

Groupe cible

Le montage des ferrures en verre DORMA ne doit être confié qu'à un personnel qualifié.

Symboles utilisés – Sécurité



Attention !

Le matériel de fixation doit correspondre aux exigences de la sous-construction/mur et au poids du vantail de porte. Observez les consignes techniques relatives au matériel de fixation.



Attention - bris de verre

Quand le vantail est accroché, des cales en bois ou équivalent doivent être placées dessous.



Attention - Risque de blessures dus à l'écrasement !

Positionner la butée d'arrêt de manière à ce que les poignées de porte (option) soient à au moins 25 mm du mur.



N'utiliser que des produits de nettoyage exempt de silicone et d'huile (par ex. de l'acétone).

Symboles utilisés – Pose



Observer le texte de remarque



Renvoi à différentes étapes de montage pour les variantes.
(Exemple : vantail en bois, étape 2)



Porte coulissante à deux vantaux



Ordre des étapes de pose



Étapes individuelles dans une étape de pose



Arête de fermeture

Consignes de sécurité

- La pose doit être effectuée par deux personnes
- Porter un équipement de protection



Utilisation conforme à l'usage prévu

- uniquement pour les portes coulissantes dans les espaces intérieurs secs
- uniquement pour une ouverture et une fermeture lentes ; le vantail doit être stoppé à la main avant d'atteindre sa position finale

Critères exigés du mur/plafond et du matériel de fixation

- La sous-construction/paroi doit avoir une capacité de charge durable, être plane et verticale (tolérance max. : 2 mm par mètre).
- Le matériel de fixation doit être approprié pour la sous-construction/mur et suffisamment dimensionné pour le poids du vantail. Observez les consignes techniques relatives au matériel de fixation.
- Le matériel de fixation ne fait pas partie de l'étendue de la livraison.

Critères exigés pour le vantail en verre :

- verre de sécurité monovitre trempé à chaud (ESG-H selon DIN EN 12150-1)
- la zone de serrage doit être plane et sans revêtement (pas de revêtement autonettoyant) !

Entretien, maintenance, réparation

- fonctionnement sans entretien pendant au moins 5 ans (pour 50 actionnements par jour)
- remplacer immédiatement les composants endommagés
- utiliser uniquement des pièces d'origine DORMA
- nettoyage occasionnel, en particulier de la surface de roulement, uniquement avec un chiffon humide

Mise au rebut

La mise au rebut dans les règles est assujettie aux prescriptions légales en vigueur dans les différents pays.

Étendue de la livraison



- 1 Profilé de recouvrement
- 2 Brosse d'occultation (en deux versions)
- 3 Protection d'arête en verre au contact vantail-mur ou vantail-vantail
- 4 Kit de guidage au sol pour vantail en verre avec possibilité de réglage du guidage



- 5 Unité DORMOTION - Option
- 6 Chariot de roulement
- 7 Starter DORMOTION - Option
- 8 Insert support de profilé de recouvrement
- 9 Rail de roulement
- 10 Butée d'arrêt pour limiter la course du vantail à l'ouverture et à la fermeture
- 11 Embout



- 12 Profilé d'encastrement
- 13 Profil porteur Pocket door
- 14 Profilé de recouvrement
- 15 Raccord pour profilé



- 16 Entretoise pour profilé de recouvrement
- 17 Embout frontal
- 18 Profilé d'élément latéral
- 19 Joint de vitrage (en trois exécutions)
- 20 Intercalaire
- 21 Profilé de remplissage
- 22 Profilé de calage verre
- 23 Profilé de sol pour verre de l'élément latéral



- 24 Profilé d'occultation
- 25 Clip de fixation



- 26 Profilé pour faux plafond suspendu





- 27 Embout frontal
- 28 Profilé additionnel montage sur verre
- 29 Plaques de fixation



- 30 Adaptateur porte bois pour fixation du chariot sur le vantail
- 31 Kit de guidage au sol pour vantail bois

Caractéristiques techniques

			
	Largeur max. du vantail [mm]	2000	2x 1250
	Épaisseur de verre du vantail [mm]	8-13,5	8-13,5
	Poids du vantail [kg]	< 80	2x < 80
	Épaisseur verre fixe [mm]	10-19	10-19
	Épaisseur de l'élément latéral en verre	8-13,5	8-13,5
	Largeur max. du vantail [mm]	2000	2x 1250
	Épaisseur du vantail bois [mm]	28-50	28-50
	Poids du vantail [kg]	< 80	2x < 80



Traduzione delle istruzioni originali
LEGGERE ATTENTAMENTE PRIMA DELL'USO
CONSERVARE PER UNA SUCCESSIVA
CONSULTAZIONE

Funzionalità del suddetto manuale

Il montaggio di ogni differente versione (esempio a parete, soffitto, con fisso laterale) è descritta separatamente. Il montaggio dei diversi sistemi sono descritti nei rispettivi capitoli del manuale.

In merito alle istruzioni

Queste istruzioni descrivono come installare il sistema scorrevole MUTO Comfort L80 con unità DORMOTION. Queste istruzioni descrivono l'installazione con porta ad apertura a sinistra. Il lato destro è speculare alla tirare sinistra.

Destinatari

Il montaggio degli accessori per vetro DORMA deve essere eseguito esclusivamente da personale specializzato, adeguatamente istruito.

Simboli utilizzati – Sicurezza



Attenzione!

Il materiale di fissaggio deve soddisfare i requisiti del substrato/della parete e del peso dell'anta della porta. Osservare le indicazioni tecniche del materiale di fissaggio.



Attenzione Rottura vetri

Nell'appendere l'anta della porta occorre collocare, sotto la stessa, blocchetti di legno o materiali simili.



Attenzione Pericolo di schiacciamento!

Posizionare il buffer/stopper in modo che le maniglie della porta (opzionali) mantengano almeno 25 mm di distanza dalla parete.



Utilizzare solo detersivi privi di siliconi ed oli (ad es. acetone).

Simboli utilizzati – Montaggio



Osservare il testo



Rimando a fasi di montaggio diverse per le diverse varianti di esecuzione (L'esempio indica: anta in legno, fase 2)

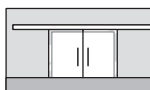

Porta scorrevole a due ante



Successione delle fasi di montaggio



Singole operazioni all'interno di una fase di montaggio



Spigolo di chiusura

Indicazioni di sicurezza

- Il montaggio deve essere eseguito da due persone
- Indossare abbigliamento antinfortunistico



Utilizzo conforme alla destinazione

- solo per porte scorrevoli in ambienti interni asciutti
- solo per un'apertura ed una chiusura manuale e lenta, l'anta deve essere fermata manualmente prima di raggiungere la posizione finale

Requisiti di parete/soffitto e materiale di fissaggio

- Il substrato/parete deve essere costantemente in grado di sopportare il peso della porta, diritto e verticale (max. tolleranza: 2 mm per metro).
- Il materiale di fissaggio deve essere adatto al substrato / parete ed essere dimensionato in modo da reggere il peso dell'anta. Osservare le indicazioni tecniche del materiale di fissaggio.
- Il materiale di fissaggio non è compreso nella dotazione.

Requisiti dell'anta in vetro:

- vetro di sicurezza monocristallo depositato a caldo (ESG-H a norma DIN EN 12150-1)
- La superficie di serraggio deve essere liscia e non trattata (nessun rivestimento autopulente!)

Manutenzione, cura, riparazione

- almeno 5 anni di funzionamento senza manutenzione (con 50 movimentazioni al giorno)
- sostituire immediatamente i componenti danneggiati
- utilizzare solo ricambi originali DORMA
- pulizia periodica, in particolare delle superfici di scorrimento, solo con un panno umido

Smaltimento

Il corretto smaltimento è soggetto alle prescrizioni delle leggi nazionali vigenti.

Dotazione



- 1 Profilo di rivestimento
- 2 Spazzolino interno (in due versioni)
- 3 Protezione spigolo di battuta in vetro anta-parete o anta-anta
- 4 Set per la guida dell'anta in vetro sul pavimento con possibilità di regolazione della guida del vetro



- 5 Unità DORMOTION - Opzionale
- 6 Carrello
- 7 Starter DORMOTION - Opzionale
- 8 Fissaggio per il profilo di rivestimento
- 9 Guida di scorrimento
- 10 Buffer/stopper per limitare l'urto dell'anta all'apertura ed alla chiusura
- 11 Tappo di chiusura



- 12 Profilo tasca
- 13 Inserto di supporto Pocket door
- 14 Profilo di rivestimento
- 15 Connettore profilo



- 16 Distanziatore per la copertura
- 17 Rivestimento frontale
- 18 Profilo per l'elemento affiancato
- 19 Guarnizione per fissaggio su vetro
- 20 (in tre differenti versioni)
- 21 Distanziatore
- 22 Profilo di riempimento
- 23 Profilo per la parete in vetro
- Alloggiamento vetro per il pavimento



- 24
- 25 Profilo di protezione a vista
Clip di fissaggio



- 26 Profilo di connessione per controsoffitto





- 27 Rivestimento frontale
- 28 Profilo di tenuta contrapposto
- 29 Piastra di tenuta

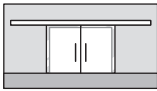

- 30 Adattatore legno per il carrello
- 31 Set di fissaggio al pavimento per ante in legno

Dati tecnici

		
Max. larghezza dell'anta [mm]	2000	2x 1250
Spessore dell'anta [mm]	8-13,5	8-13,5
Peso dell'anta [kg]	< 80	2x < 80
Spessore del vetro fisso [mm]	10-19	10-19
Spessore dell'elemento affiancato in vetro	8-13,5	8-13,5
	2000	2x 1250
Max. larghezza dell'anta [mm]	28-50	28-50
Spessore dell'anta in legno [mm]	< 80	2x < 80
Peso dell'anta [kg]		



Перевод оригинальной инструкции
ВНИМАТЕЛЬНО ПРОЧИТАЙТЕ ИНСТРУКЦИЮ ПЕРЕД
ИСПОЛЬЗОВАНИЕМ
СОХРАНИТЕ ИНСТРУКЦИЮ В КАЧЕСТВЕ СПРАВОЧНОГО
ДОКУМЕНТА

Принцип действия инструкции

В настоящей монтажной инструкции описаны процедуры установки различных версий раздвижных дверей (с креплением к стене, потолку, в составе конструкций с боковыми панелями и фрамугой). См. соответствующий раздел.

О данной инструкции

настоящие инструкции описывают монтаж системы MUTO Comfort L80 с функцией DORMOTION для раздвижных дверей. Для установки правосторонних дверей следует использовать зеркальное изображение.

Целевая группа

Монтаж фурнитуры DORMA должен осуществляться только квалифицированным персоналом, прошедшим обучение монтажу фурнитуры и систем крепления стекла.

Условные обозначения – нормы безопасности**Осторожно!**

Крепежный материал должен соответствовать требованиям несущей конструкции/стены и выдерживать вес дверных панелей. Соблюдайте технические рекомендации для крепежного материала.

**Осторожно, опасность излома стекла**

При навешивании под дверную панель следует подкладывать деревянные кубики или аналогичные предметы.

**Осторожно! Опасность защемления!**

Разместить стопор хода таким образом, чтобы дверные ручки (опционально) находились на расстоянии не менее 25 мм от стены.



Использовать только чистящие средства, не содержащие силикона и масел (к примеру, уксус).

Условные обозначения – монтаж

Обратите внимание на текстовое примечание



Ссылка на этапы монтажа, отличающиеся от стандартных, для вариантов комплектации (на примере: деревянная створка, этап 2)



Двустворчатая раздвижная дверь



Последовательность этапов монтажа



Отдельные шаги данного этапа монтажа



Кромка "панель-панель"

Рекомендации по технике безопасности

- Монтаж необходимо производить силами двух специалистов.
- Следует надевать защитную одежду:

**Использование по назначению**

- только для раздвижных дверей внутри сухих помещений
- только для медленного открывания и закрывания вручную, до достижения конца трека дверную створку следует придержать рукой

Требования к потолку/стене и крепежному материалу

- Несущая конструкция/стена должна постоянно выдерживать вес изделия, быть ровной и строго отвесной (макс. отклонение: 2 мм/м)
- Крепежный материал должен быть пригоден для использования на несущей конструкции/стене и иметь параметры, достаточные для того, чтобы выдерживать вес дверной панели.
- Необходимо соблюдать технические рекомендации для крепежного материала.
- Крепежный материал не содержится в комплекте поставки.

Требования, предъявляемые к стеклянной панели:

- однослойное термически закаленное безопасное стекло (ESG-H в соотв. с нормами DIN EN 12150-1)
- зона зажимного крепления стекла должна быть ровной и без какого-либо покрытия (запрещаются самоочищающиеся покрытия!)

Техническое обслуживание, уход, ремонт

- не менее 5 лет эксплуатации без тех. обслуживания (при 50 рабочих циклах в день)
- поврежденные детали конструкции следует немедленно заменять
- следует использовать только оригинальные запчасти DORMA
- периодическая чистка, прежде всего чистка поверхности трека, производится только влажной тканью

Утилизация

Надлежащая утилизация должна производиться в соответствии с действующими национальными законодательными нормами.

Комплект поставки



- 1 Декоративный профиль
- 2 Щеточный профиль для трека (в 2 вариантах)
- 3 Торцевая накладка для защиты кромки стеклянной панели в положении, когда дверная створка достигает стены/другой створки



- 4 Комплект для напольной направляющей для стеклянных панелей с возможностью отладки направляющей
- 5 Амортизатор DORMOTION - Опционально
- 6 Каретка
- 7 Стартер DORMOTION - Опционально
- 8 Держатель-насадка для декоративного профиля
- 9 Направляющая
- 10 Стопор хода, ограничивающий ход дверной панели в конце трека при открывании и закрывании
- 11 Концевой наконечник



- 12 Профиль выемки
- 13 Вставка держателя Pocket door
- 14 Декоративный профиль
- 15 Соединитель профиля



- 16 Дистанционная вставка крышки
- 17 Торцевая крышка
- 18 Профиль для боковой панели
- 19 Фитинг для остекления (в 3 вариантах)
- 20 Прокладка
- 21 Заполняющий профиль
- 22 Поддерживающий профиль для стекл. панели
- 23 Опора для стеклянной панели в области пола



- 24 Декоративный профиль направляющего трека
- 25 Фиксаторы



- 26 Профиль для крепления фальшпотолка





- 27 Торцевая крышка
- 28 Контрупорный профиль
- 29 Пластины-держатели



- 30 Адаптер для крепления каретки на деревянной панели
- 31 Комплект для напольной направляющей в сочетании с деревянными панелями

Технические параметры

			
	Макс. ширина панели [мм]	2000	2x 1250
	Толщина стекла д/панели [мм]	8-13,5	8-13,5
	Вес панели [кг]	< 80	2x < 80
	Толщина фиксированного стекла [мм]	10-19	10-19
	Толщина стекл. боковой панели	8-13,5	8-13,5
	Макс. ширина панели [мм]	2000	2x 1250
	Толщина деревянной панели [мм]	28-50	28-50
	Вес панели [кг]	< 80	2x < 80

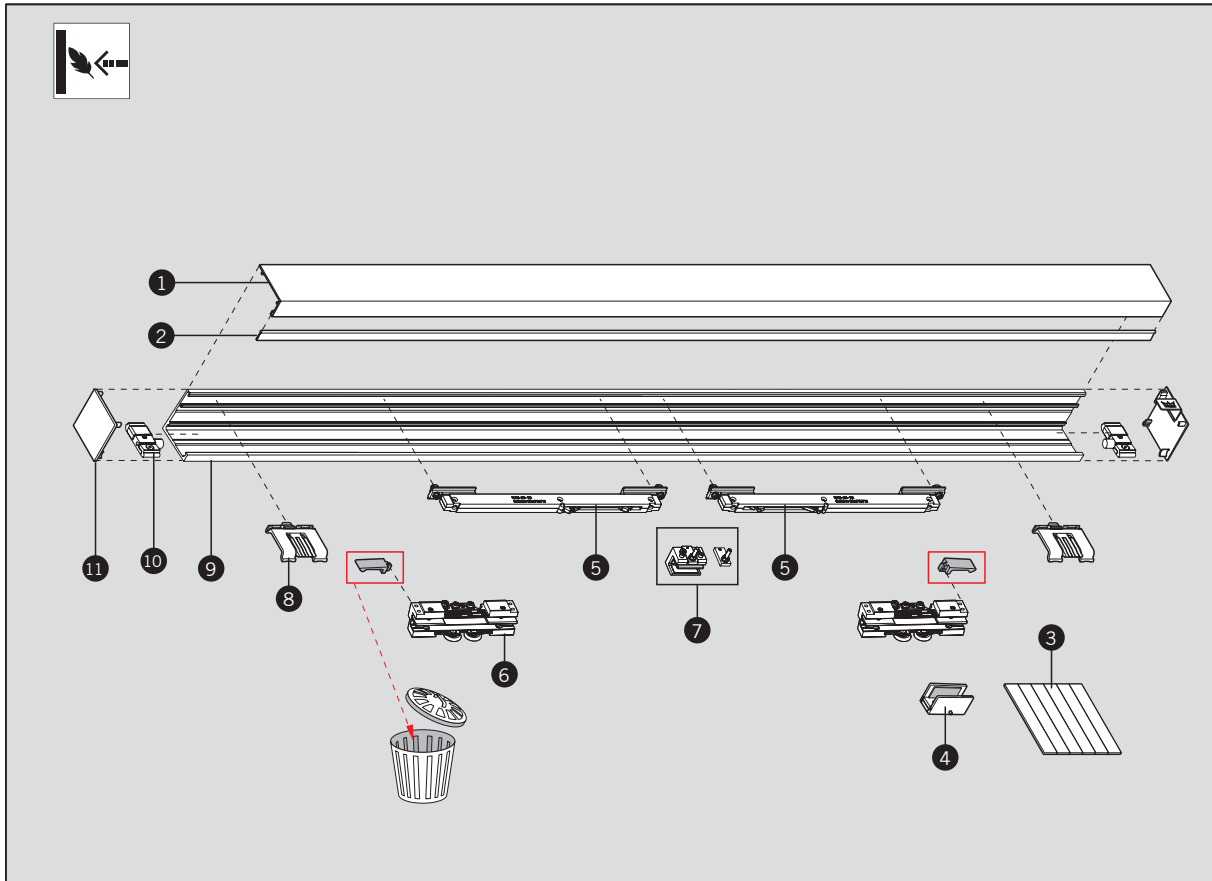

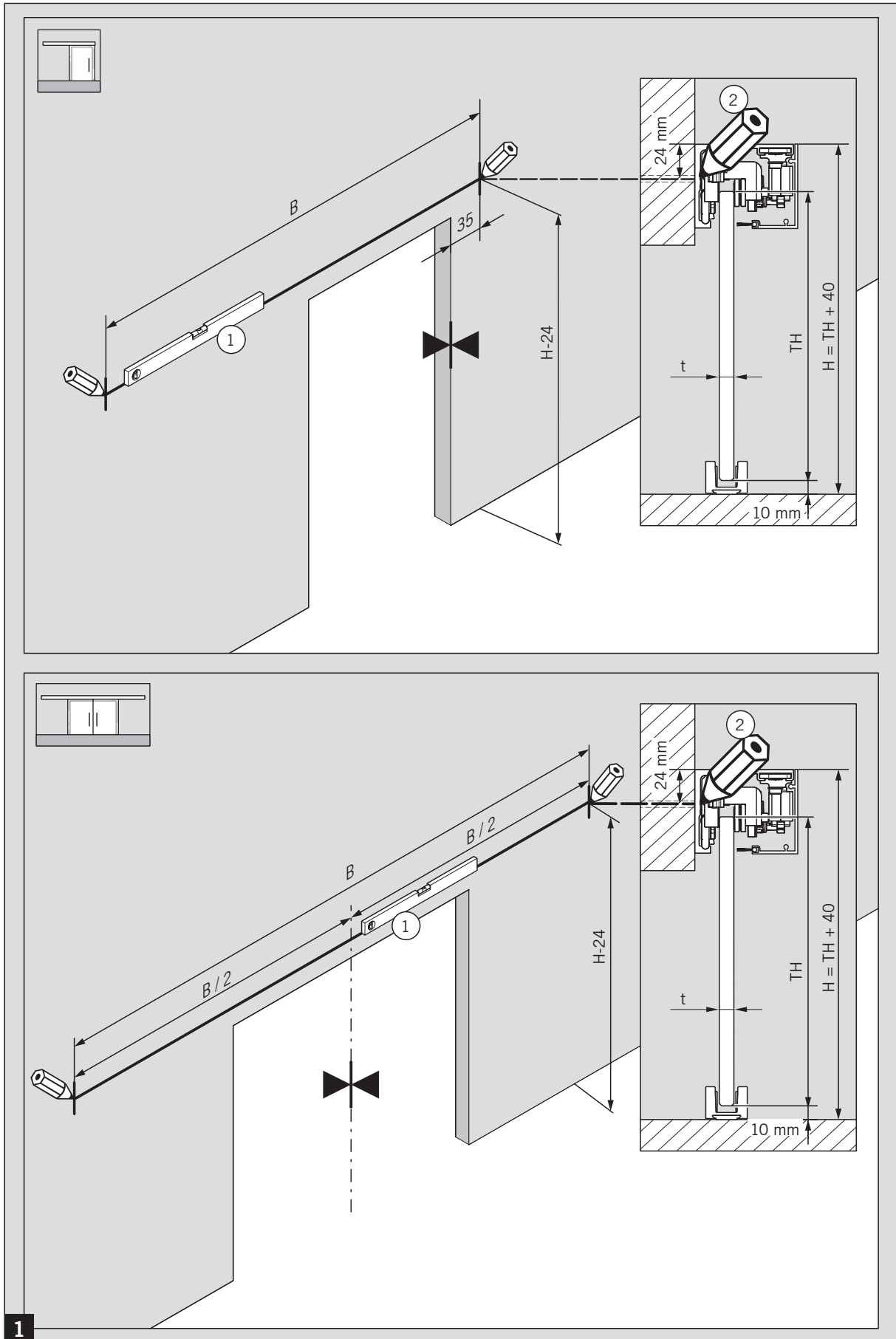

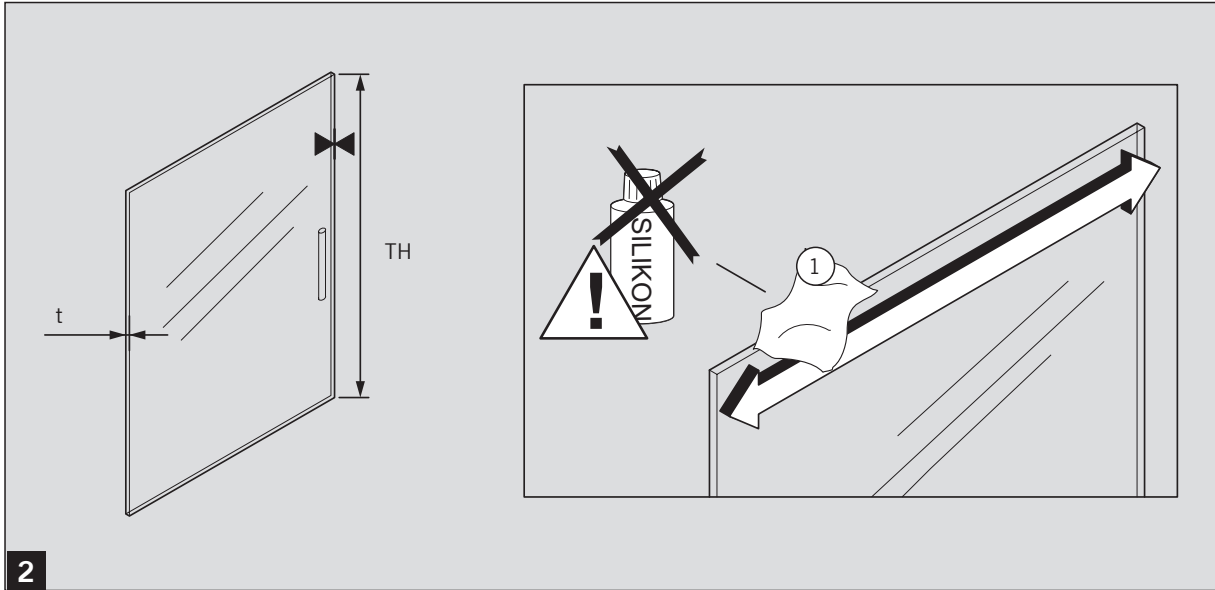

2

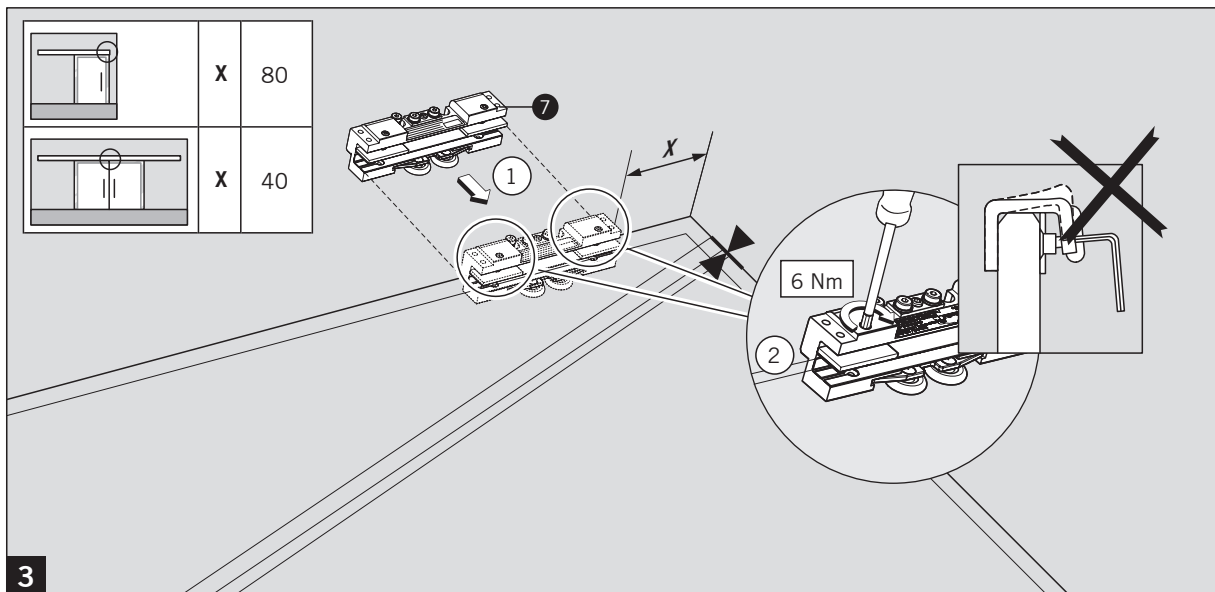

3

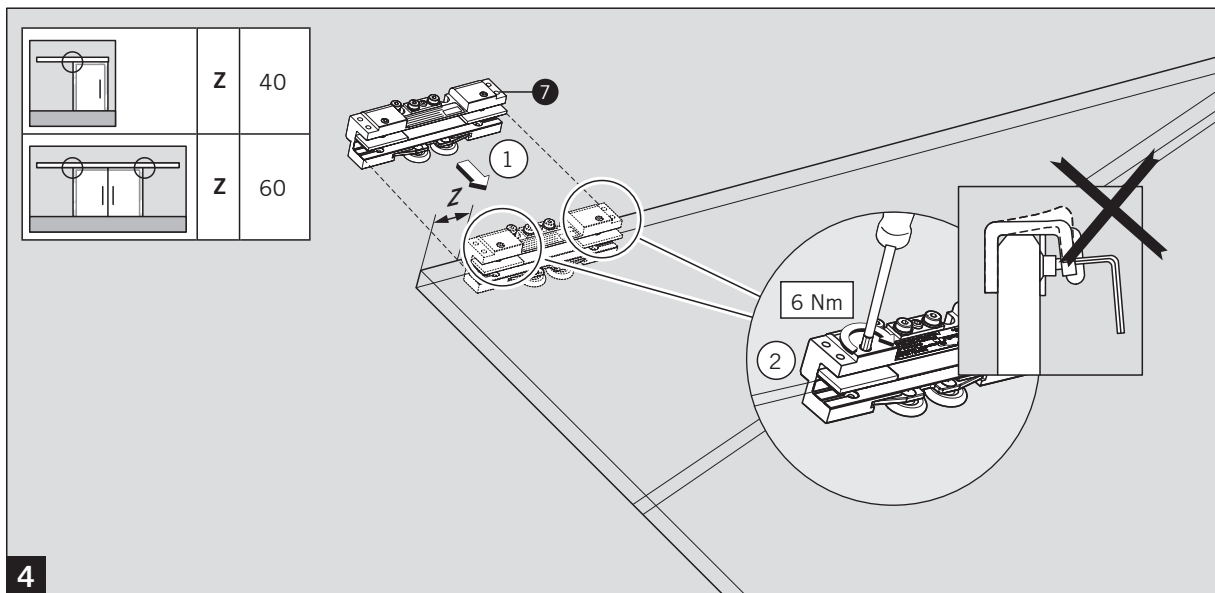

4

