



2022

Duschenwelt

Gesamtprogramm



Pauli + Sohn



Zubehör



Zubehör – Griffe

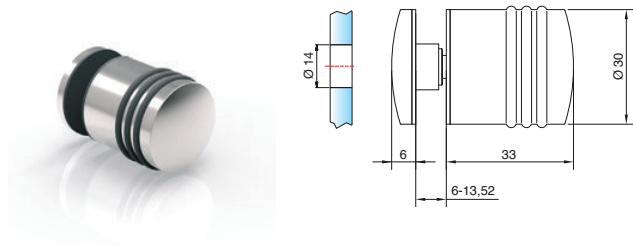

Art-Nr.	Oberfläche	Glasdicke	Artikelbezeichnung	VE/Stk.
8299ZN5	glanzverchromt	6-13,52 mm	Glastürknopf einseitig	1/1
8299ZN1	mattverchromt			
8299ZNPVD20	Goldoptik			
8299ZNPVD22	Edelstahloptik			
8299ZNPVD35	schwarz matt			
8299ZNPVD36	schwarz glänzend			

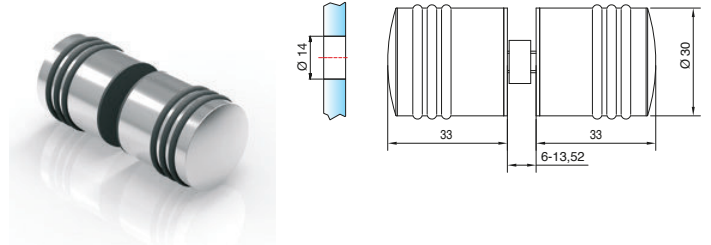

Art-Nr.	Oberfläche	Glasdicke	Bezeichnung	VE/Stk.
8298ZN5	glanzverchromt	6-13,52 mm	Glastürknopf	1/1
8298ZN1	mattverchromt		beidseitig	
8298ZNPVD20	Goldoptik			
8298ZNPVD22	Edelstahloptik			
8298ZN35	RAL9005 schwarz matt			
8298ZN36	RAL9005 schwarz glänzend			
8298ZNPVD35	schwarz matt			
8298ZNPVD36	schwarz glänzend			

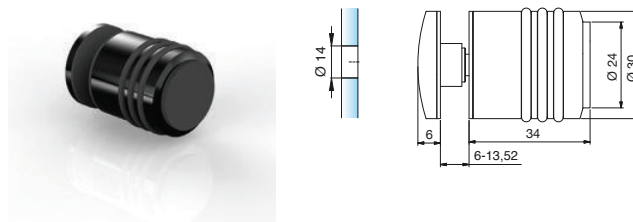

Art-Nr.	Oberfläche	Glasdicke	Artikelbezeichnung	VE/Stk.
8293ZN5	glanzverchromt	6-13,52 mm	Glastürknopf einseitig mit Gummianschlag	1/1
8293ZN1	mattverchromt			
8293ZNPVD22	Edelstahloptik			
8293ZNPVD35	schwarz matt			
8293ZNPVD36	schwarz glänzend			

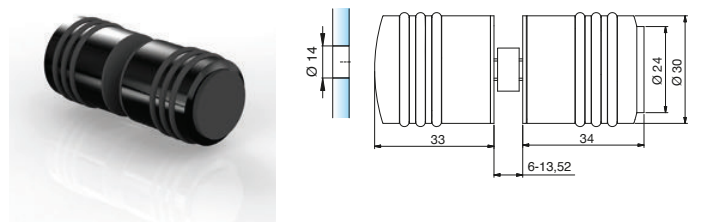

Art-Nr.	Oberfläche	Glasdicke	Artikelbezeichnung	VE/Stk.
8294ZN5	glanzverchromt	6-13,52 mm	Glastürknopf beidseitig mit Gummianschlag	1/1
8294ZN1	mattverchromt			
8294ZNPVD22	Edelstahloptik			
8294ZNPVD35	schwarz matt			
8294ZNPVD36	schwarz glänzend			

Auf Anfrage mit Gummianschlag beidseitig erhältlich (8694ZN)!

Die O-Ringe sind zu Reinigungszwecken demontierbar. Spezielle „festsitzende O-Ringe“ für den Objektbereich können unter der Artikelnummer 8298-4KU separat bezogen werden.

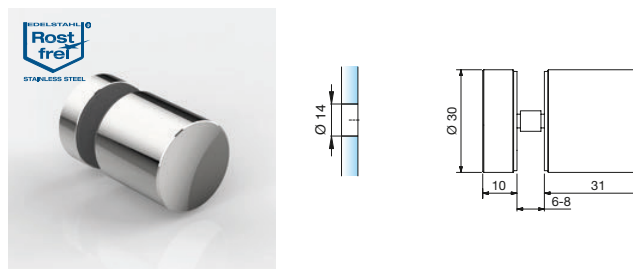

Art-Nr.	Oberfläche	Glasdicke	Artikelbezeichnung	VE/Stk.
8502VA	Edelstahl	6-8 mm	Glastürknopf einseitig	1/1

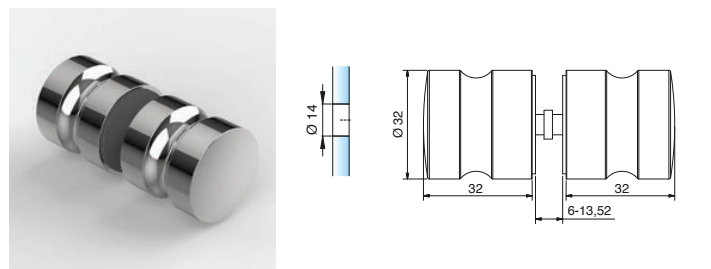

Art-Nr.	Oberfläche	Glasdicke	Artikelbezeichnung	VE/Stk.
8288ZN5	glanzverchromt	6-13,52 mm	Glastürknopf beidseitig	1/1
8288ZN1	mattverchromt			
8288ZNPVD22	Edelstahloptik			
8288ZNPVD35	schwarz matt			

Zubehör – Griffe

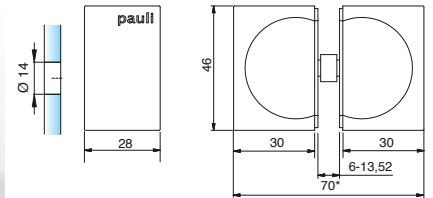
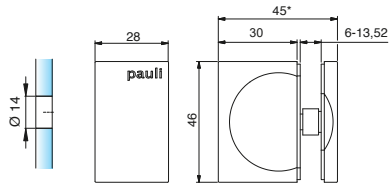

Art-Nr.	Oberfläche	Glasdicke	Artikelbezeichnung	VE/Stk.
8275ZN5	glanzverchromt	6-13,52 mm	Glastürgriff einseitig	1/1
8275ZN1	mattverchromt			
8275ZNPVD22	Edelstahloptik			
8275ZNPVD35	schwarz matt			



8278ZN

Art-Nr.	Oberfläche	Glasdicke	Artikelbezeichnung	VE/Stk.
8278ZN5	glanzverchromt	6-13,52 mm	Glastürgriff beidseitig	1/1
8278ZN1	mattverchromt			
8278ZN10	glanzvernickelt			
8278ZNPVD22	Edelstahloptik			
8278ZNPVD35	schwarz matt			
8278ZN5-A	glanzverchromt		ohne Logoeindruck	
8278ZN1-A	mattverchromt			
8278ZN10-A	glanzvernickelt			
8278ZNPVD22-A	Edelstahloptik			
8278ZNPVD20-A	Goldoptik			
8278ZNPVD35-A	schwarz matt			
8278ZNPVD36-A	schwarz glänzend			

ZUBEHÖR



Abbildung zeigt den beidseitigen Griff



Art-Nr.	Oberfläche	Glasdicke	Artikelbezeichnung	VE/Stk.
8271ZN5	glanzverchromt	6-13,52 mm	Glastürgriff einseitig	1/2
8271ZN1	mattverchromt		mit Gummianschlag	
8271ZNPVD22	Edelstahloptik		einseitig	
8271ZNPVD35-A	schwarz matt		ohne Logoeindruck	
8271ZNPVD36-A	schwarz glänzend			

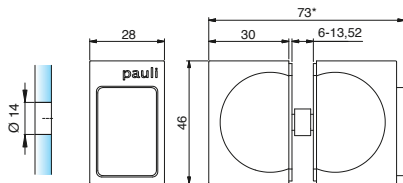
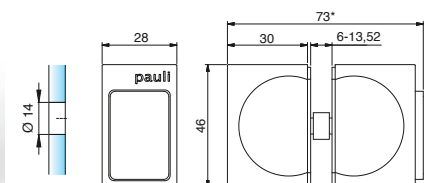
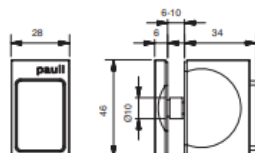

Art-Nr.	Oberfläche	Glasdicke	Artikelbezeichnung	VE/Stk.
8273ZN5	glanzverchromt	6-13,52 mm	Glastürgriff beidseitig	1/2
8273ZN1	mattverchromt		mit Gummianschlag	
8273ZNPVD22	Edelstahloptik		einseitig	
8273ZNPVD35	schwarz matt			
8273ZN5-A	glanzverchromt		ohne Logoeindruck	
8273ZN1-A	mattverchromt			
8273ZN10-A	glanzvernickelt			
8273ZNPVD22-A	Edelstahloptik			
8273ZNPVD20-A	Goldoptik			
8273ZNPVD35-A	schwarz matt			
8273ZNPVD36-A	schwarz glänzend			

Auf Anfrage mit Gummianschlag beidseitig erhältlich (8263ZN)!

*bei 8 mm Glas

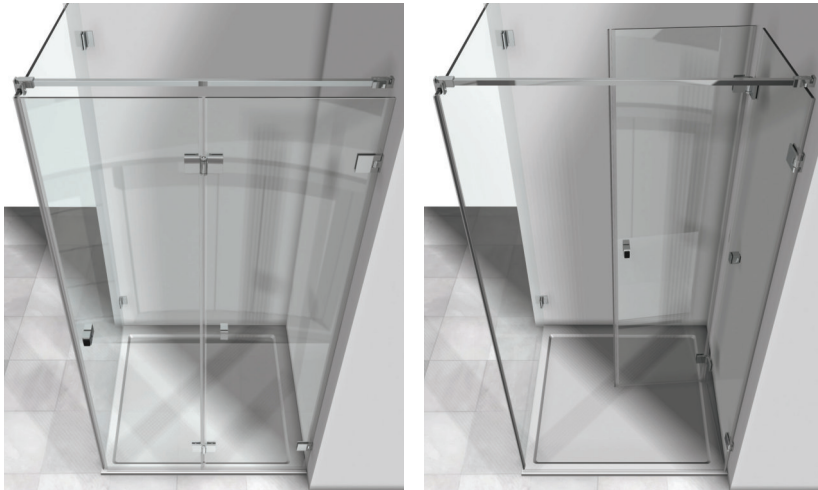

Bohrlochabstände für:



8273ZN



8271ZN

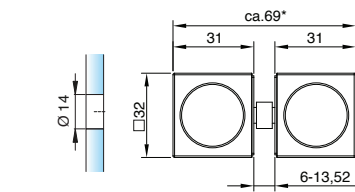
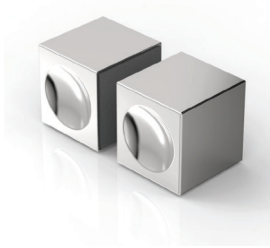
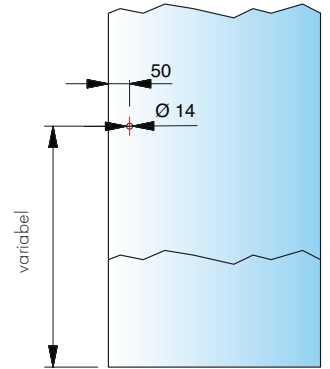

neues Design
Griffmulde verbessert

Art-Nr.	Oberfläche	Glasdicke	Artikelbezeichnung	VE/Stk.
8378ZN5	glanzverchromt	6-13,52 mm	Glastürgriff beidseitig	1/2
8378ZN1	mattverchromt			
8378ZNPVD22	Edelstahloptik			
8378ZNPVD35	schwarz matt			

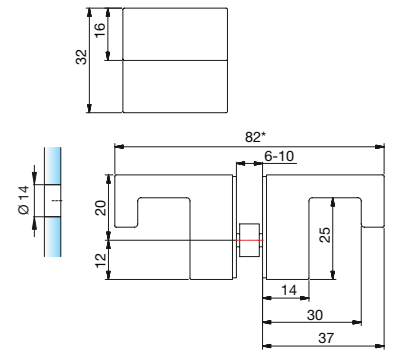

Art-Nr.	Oberfläche	Glasdicke	Artikelbezeichnung	VE/Stk.
8252MS7	glanzverchromt	6-10 mm	Glastürgriff beidseitig	1/2

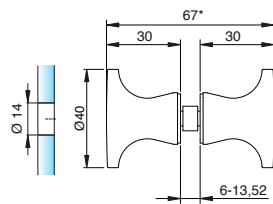

Art-Nr.	Oberfläche	Glasdicke	Artikelbezeichnung	VE/Stk.
8236ZN5	glanzverchromt	6-13,52 mm	Glastürgriff beidseitig	1/2
8236ZN1	mattverchromt			
8236ZNPVD22	Edelstahloptik			
8236ZNPVD35	schwarz matt			

*bei 8 mm Glas

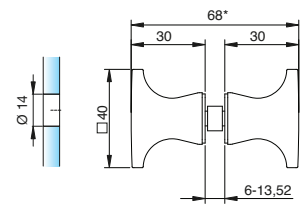

Art-Nr.	Oberfläche	Glasdicke	Artikelbezeichnung	VE/Stk.
8237ZN5	glanzverchromt	6-13,52 mm	Glastürgriff beidseitig	1/2
8237ZN1	mattverchromt			
8237ZNPVD22	Edelstahloptik			
8237ZNPVD35	schwarz matt			

Zubehör – Griffe

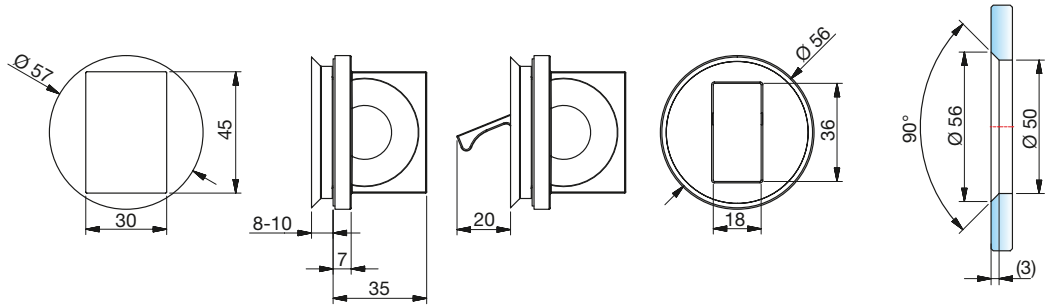

ZUBEHÖR

Art.-Nr.	Oberfläche	Glasdicke	Artikelbezeichnung	VE/Stück
8379ZN5	glanzverchromt	8-10 mm	Glastürgriff flächenbündig	1/1
8379ZN1	matverchromt		mit Griffklappe	
8379ZNPVD22	Edelstahloptik			
8379ZNPVD35	schwarz matt			
8379ZNPVD36	schwarz glänzend			

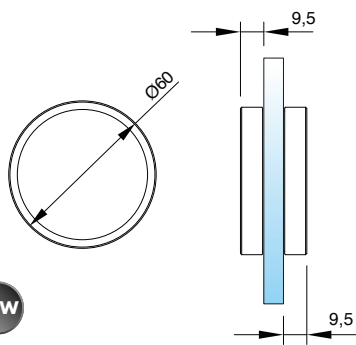

Art.-Nr.	Oberfläche	Glasdicke	Artikelbezeichnung	VE/Stück
8822MS7-MG	glanzverchromt	6-12 mm	Muchelgriff zum Aufkleben	1/1
8822MSPVD35-MG	schwarz matt		9,5 mm auftragend	

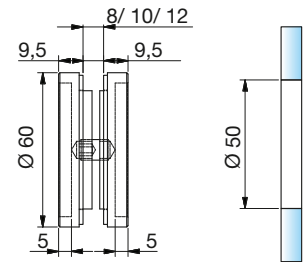
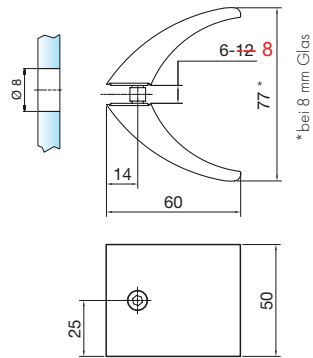

Art-Nr.	Oberfläche	Glasdicke	Bezeichnung	VE/Stk.
8297MS5-50	glanzvernickelt	6-8 mm	Glastürgriff	1/1
8297MS7-50	glanzverchromt		beidseitig	
8297MS10-50	mattverchromt			
8297MSPVD22-50	Edelstahloptik			
8297MSPVD20-50	Goldoptik			
8297MSPVD35-50	schwarz matt			
8297MSPVD36-50	schwarz glänzend			
8297MS35-50	RAL9005 schwarz matt			
8297MS36-50	RAL9005 schwarz glänzend			

Art-Nr.	Oberfläche	Glasdicke	Artikelbezeichnung	VE/Stk.
8514MS7	glanzverchromt	8/10/12 mm	Muschelgriff geschlossen	1/1
8514VA	Edelstahl		Ø 60 mm, 9,5 mm aufragend	

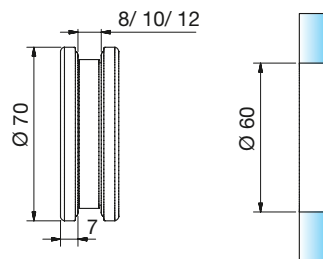

NEW

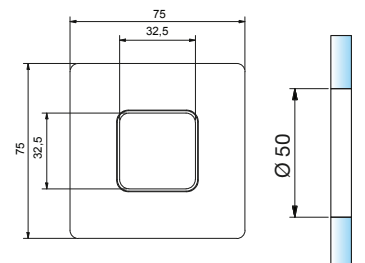

NEW

Art-Nr.	Oberfläche	Glasdicke	Artikelbezeichnung	VE/Stk.
32028VA-8	Edelstahl	8 mm	Muschelgriff offen, zum Schrauben	1/1
32028VA-10		10 mm	Ø 70 mm, 7 mm aufragend	
32028VA-12		12 mm		

Art-Nr.	Oberfläche	Glasdicke	Artikelbezeichnung	VE/Stk.
8371MS7	glanzverchromt	8 mm	Muschelgriff offen, zum Kleben	1/1
8371MS10	mattverchromt	10 mm	Ø 50 mm, 5,5 mm aufragend	
8371MSPVD22	Edelstahloptik	12 mm		
8371MSPVD35	schwarz matt			

Zubehör – Griffe

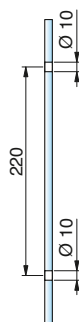
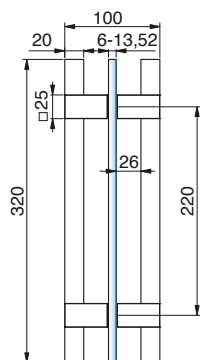

Art.-Nr.	Oberfläche	Glasdicke	Artikelbezeichnung	VE/Stück
8373ZN5-HEM	glanzverchromt/ Holz (Hemlock)	6-13,52 mm	Glastürgriff für Sauna-Anwendungen	1/1
8373ZN1-HEM	mattverchromt/ Holz (Hemlock)			
8373ZN10-HEM	glanzvernickelt/ Holz (Hemlock)			
8373ZNPVD22-HEM	Edelstahloptik/ Holz (Hemlock)			
8373ZNPVD20-HEM	Goldoptik/ Holz (Hemlock)			
8373ZNPVD35-HEM	schwarz matt/ Holz (Hemlock)			
8373ZNPVD36-HEM	schwarz glänzend/ Holz (Hemlock)			

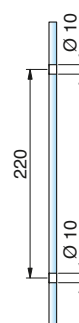
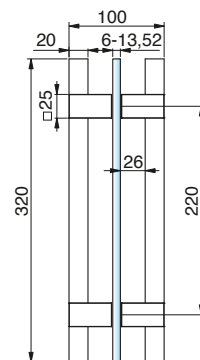

Art.-Nr.	Oberfläche	Glasdicke	Artikelbezeichnung	VE/Stück
8372MS7-HEM	glanzverchromt/ Holz (Hemlock)	6-13,52 mm	Glastürgriff für Sauna-Anwendungen,	1/1
8372MSPVD22-HEM	Edelstahloptik/ Holz (Hemlock)		Kombination Holz-Messing	
8372MSPVD35-HEM	schwarz matt/ Holz (Hemlock)			

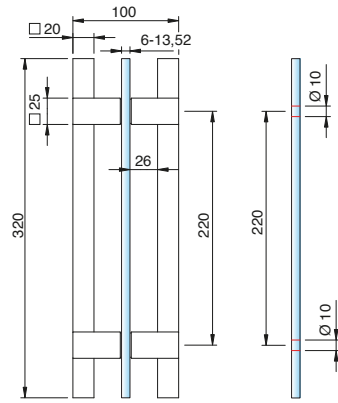

Art.-Nr.	Oberfläche	Glasdicke	Artikelbezeichnung	VE/Stück
8370MS7-320	glanzverchromt	6-13,52 mm	Glastürgriff	1/1
8370MS10-320	mattverchromt			
8370MSPVD22-320	Edelstahloptik			
8370MSPVD35-320	schwarz matt			

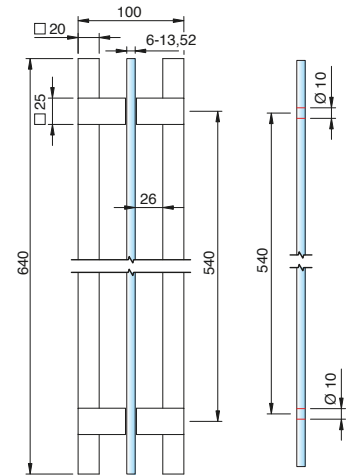

Art.-Nr.	Oberfläche	Glasdicke	Artikelbezeichnung	VE/Stück
8370MS10-640	mattverchromt	6-13,52 mm	Glastürgriff	1/1
8370MSPVD22-640	Edelstahloptik			
8370MSPVD35-640	schwarz matt			

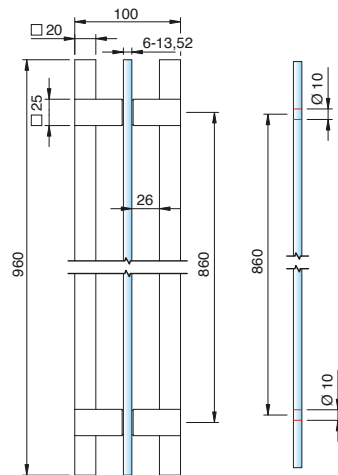

Art.-Nr.	Oberfläche	Glasdicke	Artikelbezeichnung	VE/Stück
8370MS10-960	mattverchromt	6-13,52 mm	Glastürgriff	1/1
8370MSPVD22-960	Edelstahloptik			
8370MSPVD35-960	schwarz matt			

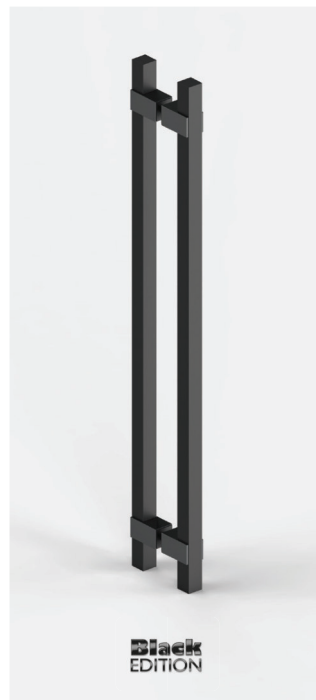

Zubehör – Griffe

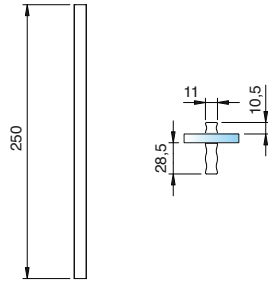
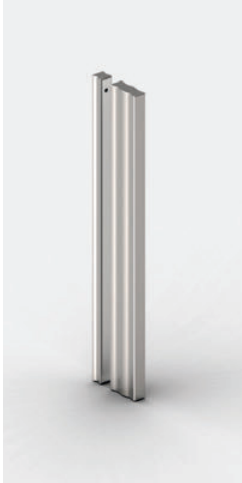

Art.-Nr.	Oberfläche*	Glasdicke	Artikelbezeichnung	VE/Stück
8822MS7-SG-250	glanzverchromt	6-12 mm	Glastürgriff zum	1/1
8822MSPVD35-SG-250	schwarz matt		Aufkleben	
8822MS10-SG-250	mattverchromt			

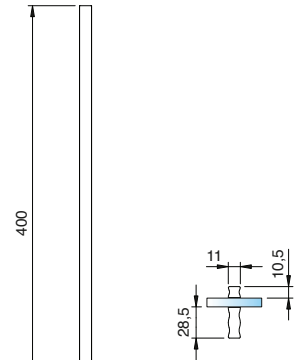
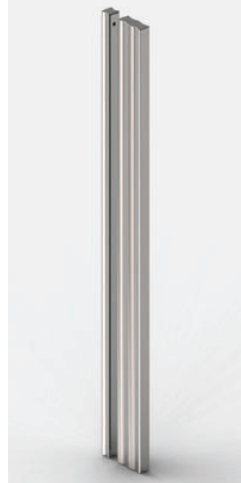

Art.-Nr.	Oberfläche*	Glasdicke	Artikelbezeichnung	VE/Stück
8822MS7-SG-400	glanzverchromt	6-12 mm	Glastürgriff zum	1/1
8822MSPVD35-SG-400	schwarz matt		Aufkleben	
8822MS10-SG-400	mattverchromt			

*ZNPVD22/ ZN1 in Vorbereitung

ZUBEHÖR

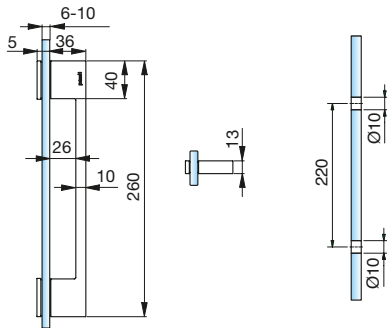

Art.-Nr.	Oberfläche	Glasdicke	Artikelbezeichnung	VE/Stück
8276ZN5	glanzverchromt	6-10 mm	Glastürgriff einseitig	1/2
8276ZN1	mattverchromt			
8276ZNPVD22	Edelstahloptik			

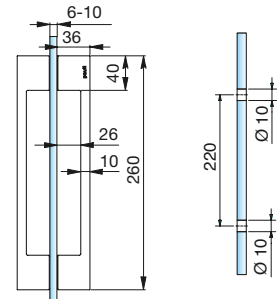

Art.-Nr.	Oberfläche	Glasdicke	Bezeichnung	VE/Stk
8277ZN5	glanzverchromt	6-10 mm	Glastürgriff	1/1
8277ZN1	mattverchromt		beidseitig	
8277ZN10	glanzvernickelt			
8277ZNPVD22	Edelstahloptik			
8277ZNPVD20	Goldoptik			
8277ZN5-A	glanzverchromt		Glastürgriff	
8277ZN1-A	mattverchromt		beidseitig	
8277ZNPVD22-A	Edelstahloptik		ohne Logo-	
8277ZNPVD35-A	schwarz matt		eindruck	
8277ZNPVD36-A	schwarz glänzend			
8277ZN35-A	RAL9005 schwarz matt			
8277ZN36-A	RAL9005 schwarz glänzend			

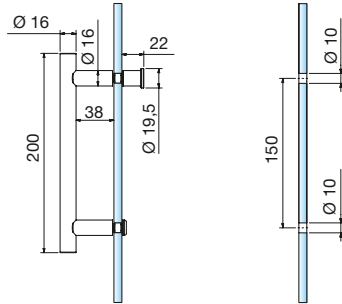

Art.-Nr.	Oberfläche	Glasdicke	Artikelbezeichnung	VE/Stück
8065VA-200	Edelstahl	6-10 mm	Stoßgriff einseitig erhaben, 1/1	
8065VA1-200	Edelstahl poliert		mit Griffstück	

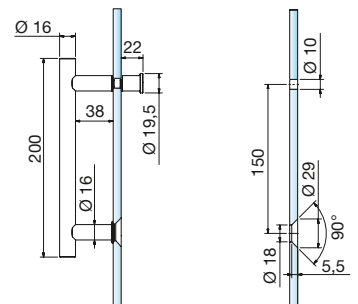

Art.-Nr.	Oberfläche	Glasdicke	Artikelbezeichnung	VE/Stück
8066VA-200	Edelstahl	6-10 mm	Stoßgriff einseitig flächen-	1/1
8066VA1-200	Edelstahl poliert		bündig, mit Griffstück	

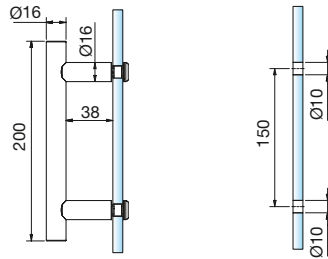

Art.-Nr.	Oberfläche	Glasdicke	Artikelbezeichnung	VE/Stück
8061VA-200	Edelstahl	6-10 mm	Stoßgriff einseitig erhaben	1/1
8061VA1-200	Edelstahl poliert			

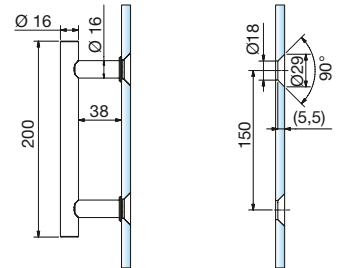
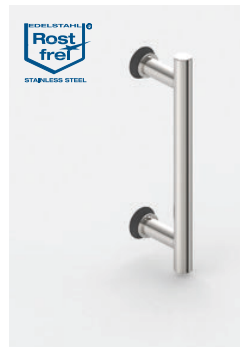

Art.-Nr.	Oberfläche	Glasdicke	Artikelbezeichnung	VE/Stück
8062VA-200	Edelstahl	6-10 mm	Stoßgriff einseitig	1/1
8062VA1-200	Edelstahl poliert		flächenbündig	

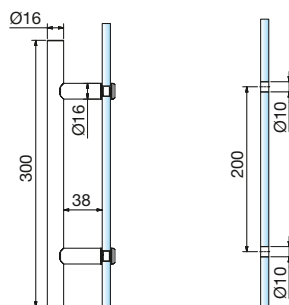
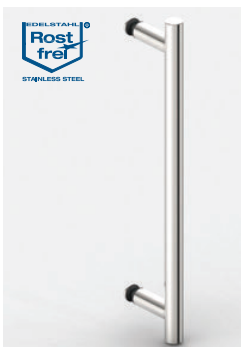

Art.-Nr.	Oberfläche	Glasdicke	Artikelbezeichnung	VE/Stück
8061VA-300	Edelstahl	6-10 mm	Stoßgriff einseitig erhaben	1/1
8061VA1-300	Edelstahl poliert			

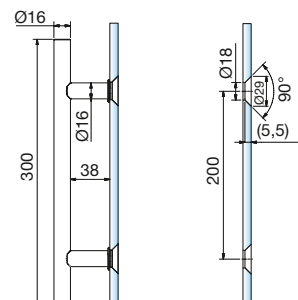

Art.-Nr.	Oberfläche	Glasdicke	Artikelbezeichnung	VE/Stück
8062VA-300	Edelstahl	6-10 mm	Stoßgriff einseitig	1/1
8062VA1-300	Edelstahl poliert		flächenbündig	

Zubehör – Griffe

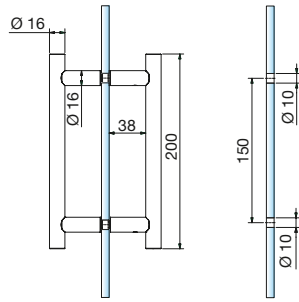

Art.-Nr.	Oberfläche	Glasdicke	Artikelbezeichnung	VE/Stück
8060VA-200	Edelstahl	6-10 mm	Stoßgriff beidseitig	1/1
8060VA1-200	Edelstahl poliert			

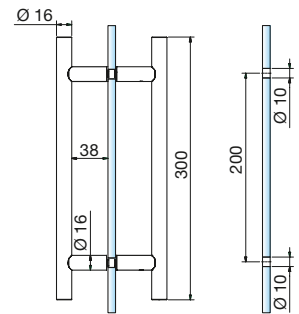

Art.-Nr.	Oberfläche	Glasdicke	Artikelbezeichnung	VE/Stück
8060VA-300	Edelstahl	6-10 mm	Stoßgriff beidseitig	1/1
8060VA1-300	Edelstahl poliert			

Wie es Ihnen gefällt – Edle Oberflächen und Farben

Darf's ein bisschen anders sein? Außer Edelstahl und Chrom bieten wir Ihnen eine Auswahl an attraktiven Trendfarben und Oberflächen für unsere Beschläge an, wie zum Beispiel Gold oder schwarz glänzend. Noch individueller und exklusiver geht's mit unseren Sonderfarben, wie Kupfer, Bronze oder Roségold – unser Geheimtipp gegen Einheitschrom.

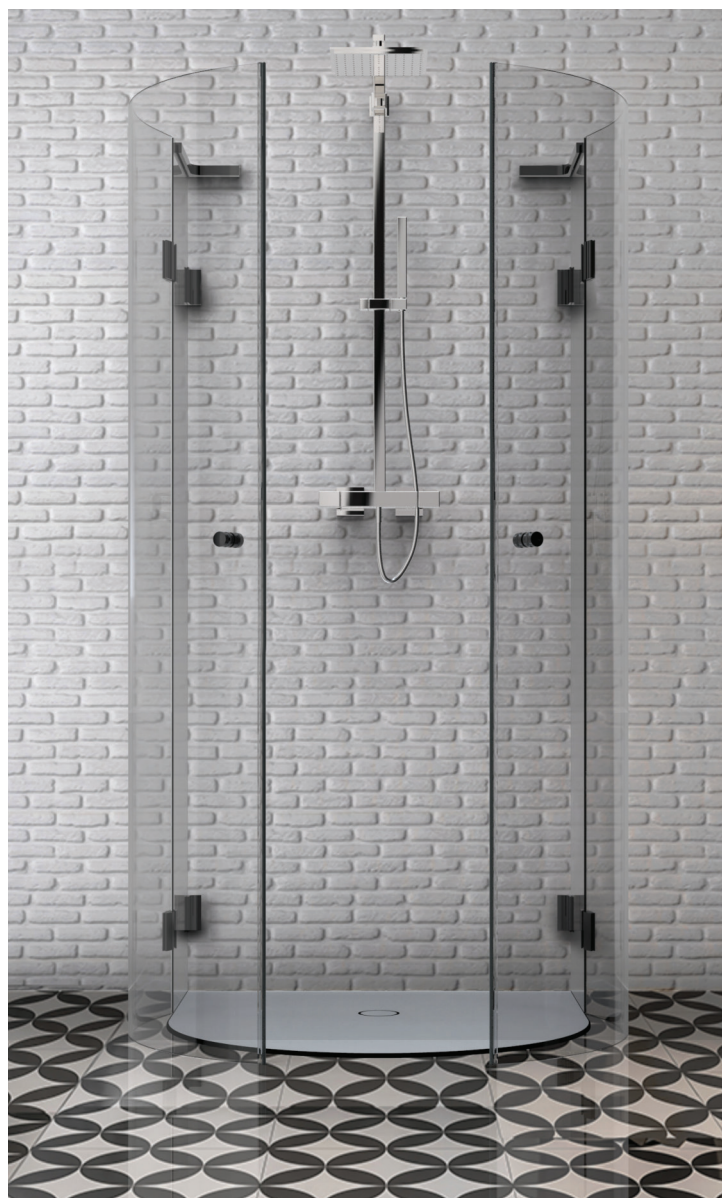

Standardfarben



ZNPVD36
schwarz glänzend



ZNPVD35
schwarz matt



ZNPVD20
Goldoptik



ZN5
glanzverchromt



ZN1
mattverchromt



ZNPVD22
Edelstahloptik



ZN10
glanzvernickelt

C88 Muster-Platte mit allen
Standard-Oberflächen

Sonderfarben auf Anfrage



CRG
Roségold glänzend



KBP
Bronze glänzend



KU
Kupfer glänzend



CRB
Roségold matt



KBR
Bronze matt



KGK
Kupfer matt



Pauli + Sohn GmbH

Werk I:

Eisenstraße 2

D-51545 Waldbröl

Telefon: +49 (0) 22 91-92 06-0

Fax: +49 (0) 22 91-92 06-681

Werk II:

Industriestraße 20

D-51597 Morsbach

Telefon: +49 (0) 22 94-98 03-0

Fax: +49 (0) 22 94-98 03-881

www.pauli.de

info@pauli.de