



2022

Duschenwelt

Gesamtprogramm



Pauli + Sohn



Zubehör

Zubehör – Stabilisierungswinkel

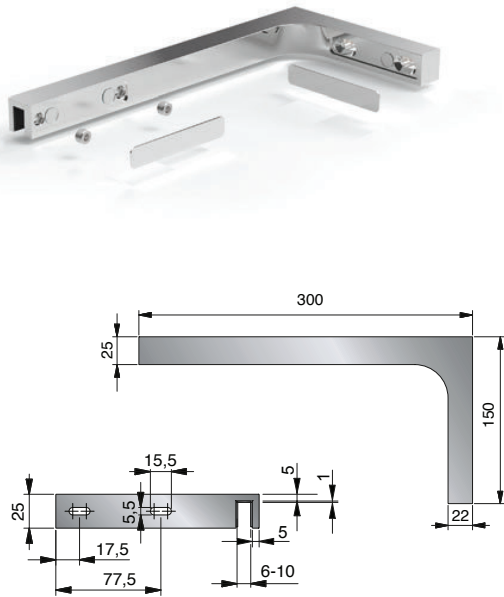

Merkmale

Stabilisierungswinkel mit Langlochverstellung an der Wandseite, aufsteckbar auf Glasoberkante, keine Glasbearbeitung, verdeckte Verschraubung



Art.-Nr.	Oberfläche	Glasdicke	Artikelbezeichnung	VE/Stk
8449MS7-L	glanzverchromt	6/8/10 mm	Stabilisierungswinkel links	1/1
8449MS10-L	mattverchromt			
8449MSPVD22-L	Edelstahloptik			
8449MSPVD35-L	schwarz matt			
8449MSPVD36-L	schwarz glänzend			

Art.-Nr.	Oberfläche	Glasdicke	Artikelbezeichnung	VE/Stk
8449MS7-R	glanzverchromt	6/8/10 mm	Stabilisierungswinkel rechts	1/1
8449MS10-R	mattverchromt			
8449MSPVD22-R	Edelstahloptik			
8449MSPVD35-R	schwarz matt			
8449MSPVD36-R	schwarz glänzend			

Nischenduschen



Eckduschen



Fünfeckduschen



Badewannen





Zubehör – verstellbarer Stabilisierungswinkel

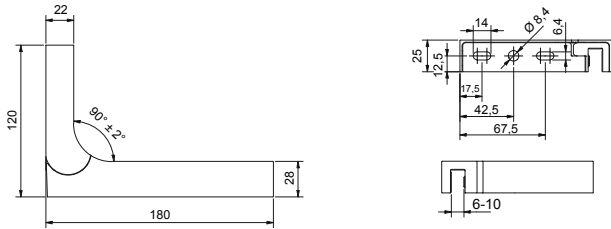
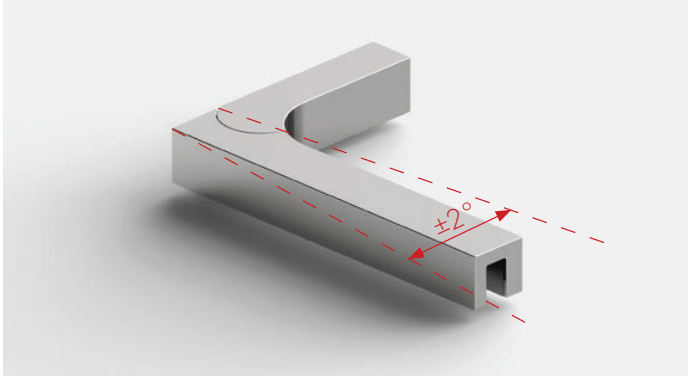

Art.-Nr.	Oberfläche	Glasdicke	Bezeichnung	VE/Stk
8439ZN5L-180	glanzverchromt	6/8/10 mm	Stabilisierungswinkel, links	1/1
8439ZN1L-180	mattverchromt		Verstellmöglichkeit	
8439ZN10L-180	glanzvernickelt		90° ± 2°	
8439ZNPVD22L-180	Edelstahloptik			
8439ZNPVD20L-180	Goldoptik			
8439ZNPVD35L-180	schwarz matt			
8439ZNPVD36L-180	schwarz glänzend			
8439ZN35L-180	schwarz matt			
8439ZN36L-180	schwarz glänzend			

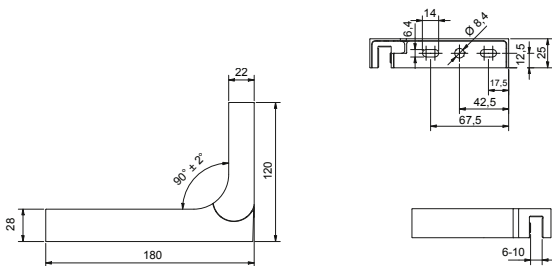

Art.-Nr.	Oberfläche	Glasdicke	Bezeichnung	VE/Stk
8439ZN5R-180	glanzverchromt	6/8/10 mm	Stabilisierungswinkel, rechts	1/1
8439ZN1R-180	mattverchromt		Verstellmöglichkeit	
8439ZN10R-180	glanzvernickelt		90° ± 2°	
8439ZNPVD22R-180	Edelstahloptik			
8439ZNPVD20R-180	Goldoptik			
8439ZNPVD35R-180	schwarz matt			
8439ZNPVD36R-180	schwarz glänzend			
8439ZN35R-180	schwarz matt			
8439ZN36R-180	schwarz glänzend			

Zubehör – verstellbarer Stabilisierungswinkel

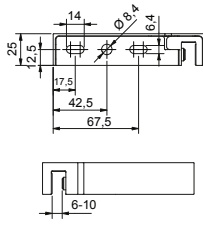
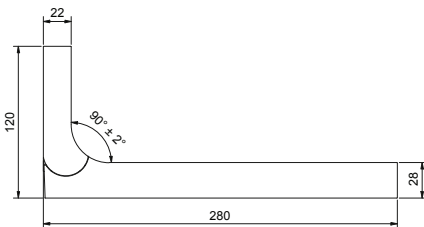
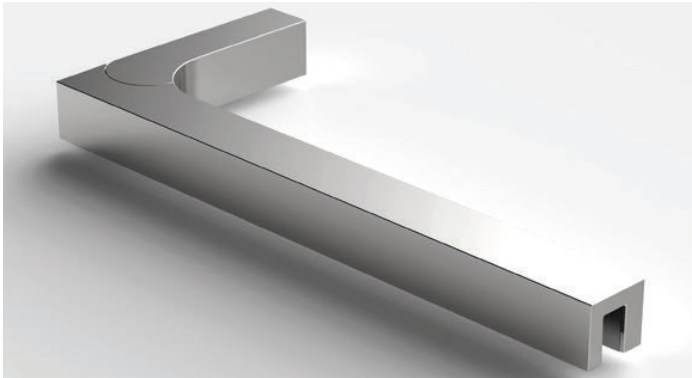

Art.-Nr.	Oberfläche	Glasdicke	Bezeichnung	VE/Stk
8439ZN5L-280	glanzverchromt	6/8/10 mm	Stabilisierungswinkel, links	1/1
8439ZN1L-280	matzverchromt		Verstellmöglichkeit	
8439ZN10L-280	glanzvernickelt		90° ± 2°	
8439ZNPVD22L-280	Edelstahloptik			
8439ZNPVD20L-280	Goldoptik			
8439ZNPVD35L-280	schwarz matt			
8439ZNPVD36L-280	schwarz glänzend			
8439ZN35L-280	schwarz matt			
8439ZN36L-280	schwarz glänzend			

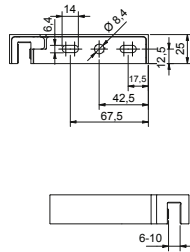
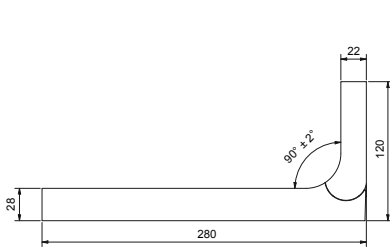
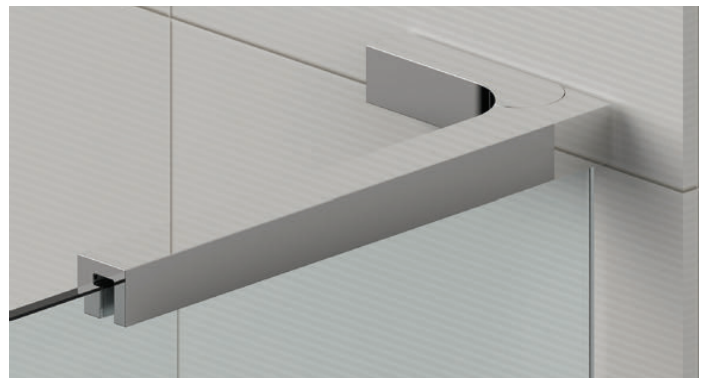
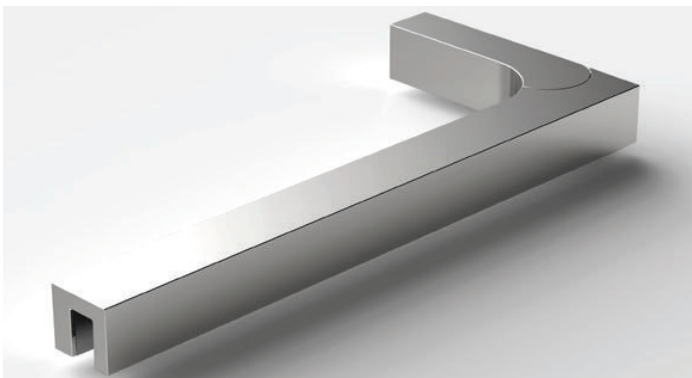

Art.-Nr.	Oberfläche	Glasdicke	Bezeichnung	VE/Stk
8439ZN5R-280	glanzverchromt	6/8/10 mm	Stabilisierungswinkel, rechts	1/1
8439ZN1R-280	matzverchromt		Verstellmöglichkeit	
8439ZN10R-280	glanzvernickelt		90° ± 2°	
8439ZNPVD22R-280	Edelstahloptik			
8439ZNPVD20R-280	Goldoptik			
8439ZNPVD35R-280	schwarz matt			
8439ZNPVD36R-280	schwarz glänzend			
8439ZN35R-280	schwarz matt			
8439ZN36R-280	schwarz glänzend			

Zubehör – Stabilisierungswinkel Glas-Glas

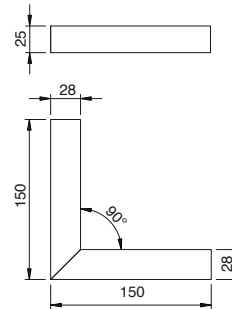
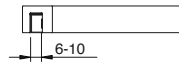

Art.-Nr.	Oberfläche	Glasdicke	Artikelbezeichnung	VE/Stück
8438ZN5-150	glanzverchromt	6/8/10 mm	Stabilisierungswinkel Glas-Glas	1/1
8438ZN1-150	mattverchromt			
8438ZN10-150	glanzvernickelt			
8438ZNPVD22-150	Edelstahloptik			
8438ZNPVD20-150	Goldoptik			
8438ZNPVD35-150	schwarz matt			
8438ZNPVD36-150	schwarz glänzend			
8438ZN35-150	schwarz matt			
8438ZN36-150	schwarz glänzend			

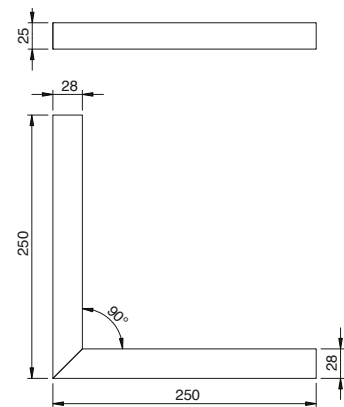
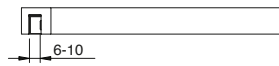

Art.-Nr.	Oberfläche	Glasdicke	Artikelbezeichnung	VE/Stück
8438ZN5-250	glanzverchromt	6/8/10 mm	Stabilisierungswinkel Glas-Glas	1/1
8438ZN1-250	mattverchromt			
8438ZN10-250	glanzvernickelt			
8438ZNPVD22-250	Edelstahloptik			
8438ZNPVD20-250	Goldoptik			
8438ZNPVD35-250	schwarz matt			
8438ZNPVD36-250	schwarz glänzend			
8438ZN35-250	schwarz matt			
8438ZN36-250	schwarz glänzend			



Wie es Ihnen gefällt – Edle Oberflächen und Farben

Darf's ein bisschen anders sein? Außer Edelstahl und Chrom bieten wir Ihnen eine Auswahl an attraktiven Trendfarben und Oberflächen für unsere Beschläge an, wie zum Beispiel Gold oder schwarz glänzend. Noch individueller und exklusiver geht's mit unseren Sonderfarben, wie Kupfer, Bronze oder Roségold – unser Geheimtipp gegen Einheitschrom.



Standardfarben



ZNPVD36
schwarz glänzend



ZNPVD35
schwarz matt



ZNPVD20
Goldoptik



ZN5
glanzverchromt



ZN1
mattverchromt



ZNPVD22
Edelstahloptik



ZN10
glanzvernickelt

C88 Muster-Platte mit allen
Standard-Oberflächen

Sonderfarben auf Anfrage



CRG
Roségold glänzend



KBP
Bronze glänzend



KU
Kupfer glänzend



CRB
Roségold matt



KBR
Bronze matt



GKG
Kupfer matt



Pauli + Sohn GmbH

Werk I:

Eisenstraße 2

D-51545 Waldbröl

Telefon: +49 (0) 22 91-92 06-0

Fax: +49 (0) 22 91-92 06-681

Werk II:

Industriestraße 20

D-51597 Morsbach

Telefon: +49 (0) 22 94-98 03-0

Fax: +49 (0) 22 94-98 03-881

www.pauli.de

info@pauli.de