

Typ(e) 120

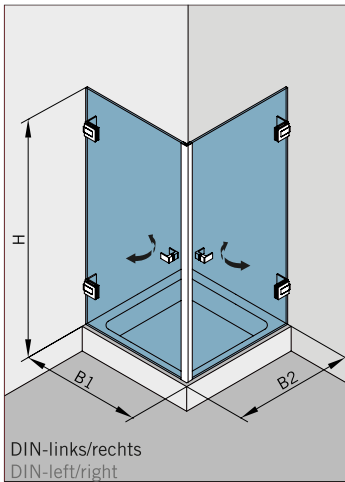

Art.-Nr. Art. No.	Bezeichnung	Description
70.180 4 (St. pce)	Band Glas/Wand, einseitige Anschraublasche	Hinge glass/wall, single-sided fixing plate
74.017 2 (St. pce)	Wasserabweiser, für 8 mm Glas	Water disperser, for 8 mm glass
74.052 1 (St. pce)	Magnetdichtung 90°, für 8 mm Glas	Magnetic seal 90°, for 8 mm glass
74.025 2 (St. pce)	Schlauchdichtung, für 8 mm Glas	Soft nose seal, for 8 mm glass
70.187 2 (St. pce)	Türgriff, für 8 mm Glas	Door handle, for 8 mm glass

Details

