

Technische Dokumentation | Technical documentation



SF 740 PREMIUM Wandmontage | Wall fixing

Schiebetürsystem mit
Dämpfungs- &
Einzugsfunktion
Sliding door system with
damping & self-closing
function



Technische Daten

- verdeckte Klemmlaufwagen (ohne Glasbearbeitung)
- beidseitige Dämpfung inkl. beidseitiger Einzugsfunktion
- stufenlos einstellbare Dämpferposition (Einzugsweg 55 mm)
- vormontierte Funktionselemente
- einfache Höhenverstellung (+3/-3 mm)
- Türflügel einfach zum Einhängen
- max. Laufschiene­länge: 2900 mm (mit Kontaktstellen)
- teilbare Bodenführung für einfache Reinigung
- Dichtungsverzicht bei überlapp. Glaselementen (40 mm)
- geklebte Griffleiste inkl. Montageschablone
- wandseitig in Glas­auf­nahme­profil (Verstell­mög­lichk.: -10 mm)
- wandseitig ohne Glas­auf­nahme­profil (auf Kundenwunsch)
- max. Tür­ge­wicht: 50 kg
- max. Tür­brei­te: individuell je Einbausituation
- min. Tür­brei­te: 400 mm (8/10 mm)
- Glas­stär­ke: 8/10 mm
- Grundmaterial: Aluminium (korrosionsbeständig)
- Standardoberflächen: verchromt (LM gegläntzt)
RAL Sonderfarbe
- weitere Oberflächen: auf Anfrage

Technical data

- concealed clamp-type carriers (no glass preparation)
- damping and self-closing on both sides
- infinitely variable damper position (pull-in distance 55 mm)
- pre-fitted functional elements
- easy height adjustment (+3/-3 mm)
- easy to hang the door
- max. sliding frame length: 2900 mm (with contact pods)
- separable floor guide
- overlapping glass elements for seal-free design (40 mm)
- glued handle bar incl. mounting instruction
- sidewall with glass support profile (Adjustability: -10 mm)
- sidewall without glass support profile (on demand)
- max. door weight: 50 kg
- max. door width: individual each installation situation
- min. door width: 400 mm (8/10 mm)
- glass thickness: 8/10 mm
- basic material: aluminium (corrosion resistant)
- standard surfaces: pol. chrome (LM visually effect pol. chrome)
RAL special coated colour
- further surfaces: on request



6 JAHRE GARANTIE
YEARS WARRANTY
* long life product *

Einbausituationen | Installation situation

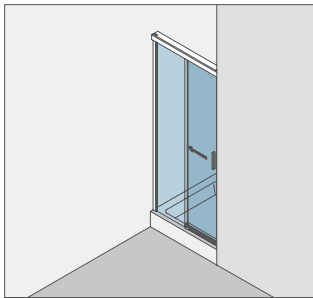

Typ(e) 300(ü)
 Nischenkabine
 1 Schiebetür mit Fixteil

Niche cubicle
 1 Sliding door with fixed panel

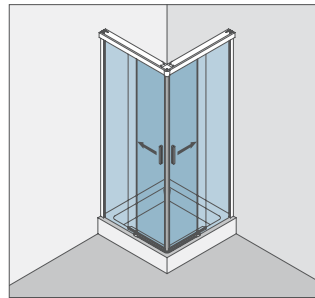

Typ(e) 320(ü)
 Eckkabine,
 2 Schiebetüren 90° mit 2 Fixteilen

Corner cubicle,
 2 Sliding doors 90° with 2 fixed panels

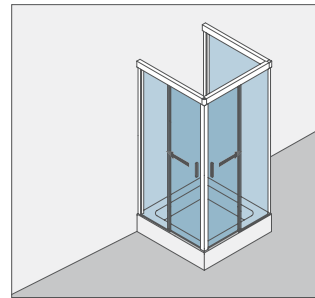

Typ(e) 323(ü)
 U-Kabine,
 2 Schiebetüren 90° mit 2 Fixteilen,
 1 Seitenwand 90°

U-shaped cubicle,
 2 Sliding doors 90° with 2 fixed panels, 1 side panel 90°

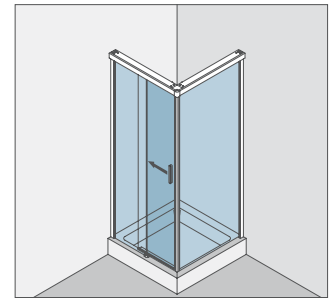

Typ(e) 330(ü)
 Eckkabine,
 1 Schiebetür mit Fixteil,
 1 Seitenwand 90°

Corner cubicle,
 1 Sliding door with fixed panel,
 1 side panel 90°

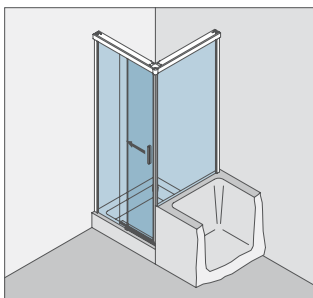

Typ(e) 331(ü)
 Eckkabine an Badewanne,
 1 Schiebetür mit Fixteil,
 1 verkürzte Seitenwand 90°

Corner cubicle on bathtub,
 1 Sliding door with fixed panel,
 1 side panel 90°

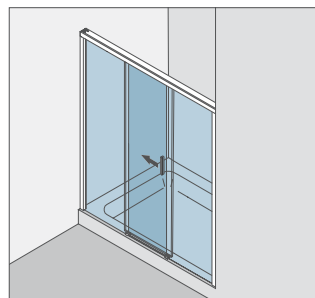

Typ(e) 370(ü)
 Nischenkabine,
 1 Schiebetür mit 2 Fixteilen

Niche cubicle,
 1 Sliding door with 2 fixed panels

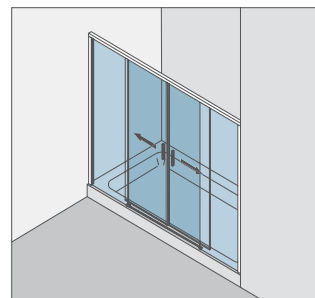

Typ(e) 375(ü)DT
 Nischenkabine,
 2 Schiebetüren mit 2 Fixteilen

Niche cubicle,
 2 Sliding doors with 2 fixed panels

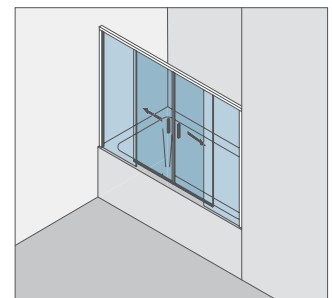

Typ(e) 375(ü)BW
 Nischenkabine auf Badewanne,
 2 Schiebetüren mit 2 Fixteilen

Niche cubicle on bathtub,
 2 Sliding doors with 2 fixed panels

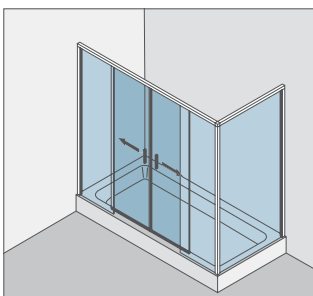

Typ(e) 380(ü)DT
 Eckkabine,
 2 Schiebetüren mit 2 Fixteilen,
 1 Seitenwand 90°

Corner cubicle,
 2 Sliding doors with 2 fixed panels,
 1 Side panel 90°

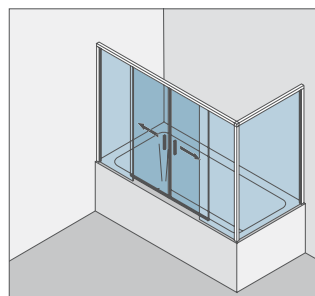

Typ(e) 380(ü)BW
 Eckkabine auf Badewanne,
 2 Schiebetüren mit 2 Fixteilen,
 1 Seitenwand 90°

Corner cubicle on bathtub,
 2 Sliding doors with 2 fixed panels,
 1 Side panel 90°

Typ(e) 370(ü)

Max. Türbreite bei Türhöhe 2000 mm | Max. door width with door height 2000 mm:
1250 mm (8 mm) / 1000 mm (10 mm)
Überhöhen auf Anfrage | Oversize height on request

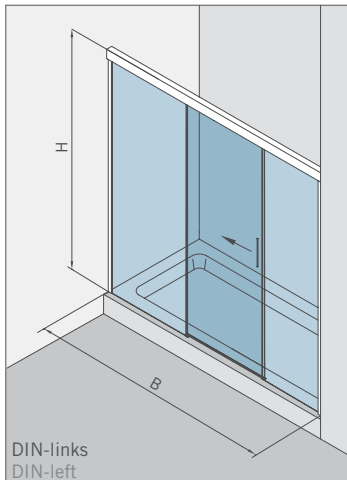

Art.-Nr. Art. No.	Bezeichnung	Description
74.237 1 (St. pce)	Wasserabweiser für 8-10 mm Glas, 2000 mm lang	Water dispenser for 8-10 mm glass, 2000 mm long
74.240 4 (St. pce)	Glasschutz, PVC weich, für 8 mm Glas, 2000 mm lang	Glass protection, PVC soft, for 8 mm glass, 2000 mm long
74.241 4 (St. pce)	Glasschutz, PVC weich, für 10 mm Glas, 2000 mm lang	Glass protection, PVC soft, for 10 mm glass, 2000 mm long
74.138 2 (St. pce)	Wandanschlussprofil für 8-10 mm Glas, 2000 mm lang	Wall conection profile for 8-10 mm glass, 2000 mm long
75.025 1 (St. pce)	Schiebetürgriffeleiste, selbstklebend, inkl. Montageschablone	Sliding door handle bar, self-adhesive, incl. mounting instruction
75.086 (75.087) 1 (St. pce)	Flügelführungsstück, teilbar, für Schiebetürflügel DIN-R (DIN-L), für 8-10 mm Glas	Glass guide, separable, for sliding door DIN-R (DIN-L), for 8-10 mm glass
74.069 1 (St. pce)	Schwallschutzprofil, 2000 mm lang (optional)	Splashguard profile, 2000 mm long (optional)

Details

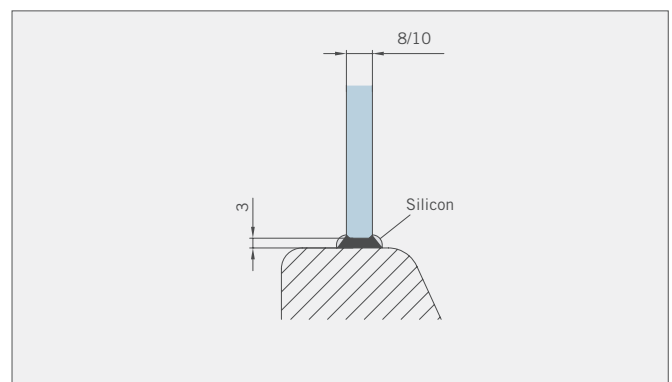
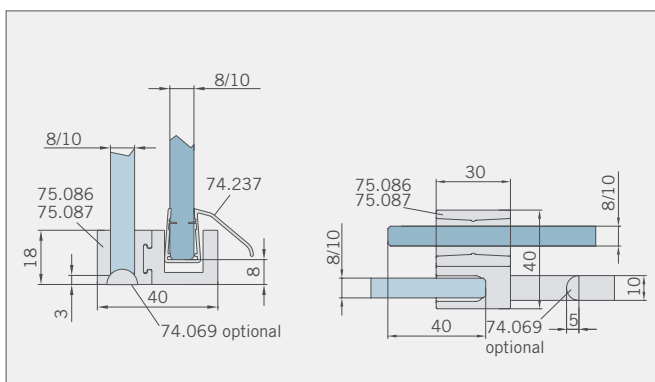
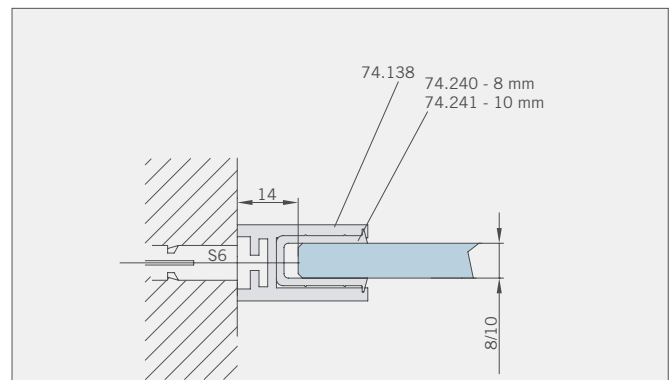
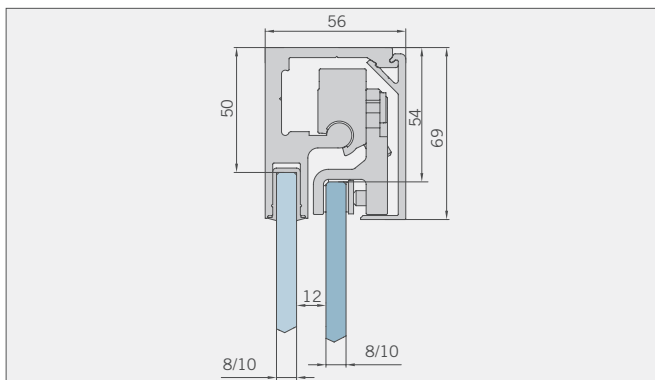

Typ(e) 370(ü)

Draufsicht / Für Duschen **mit/ohne** Duschtasse / DIN-links (DIN-rechts spiegelbildlich)
Top view / For showers **with/without** shower tray / DIN-left (DIN-right mirror-inverted)

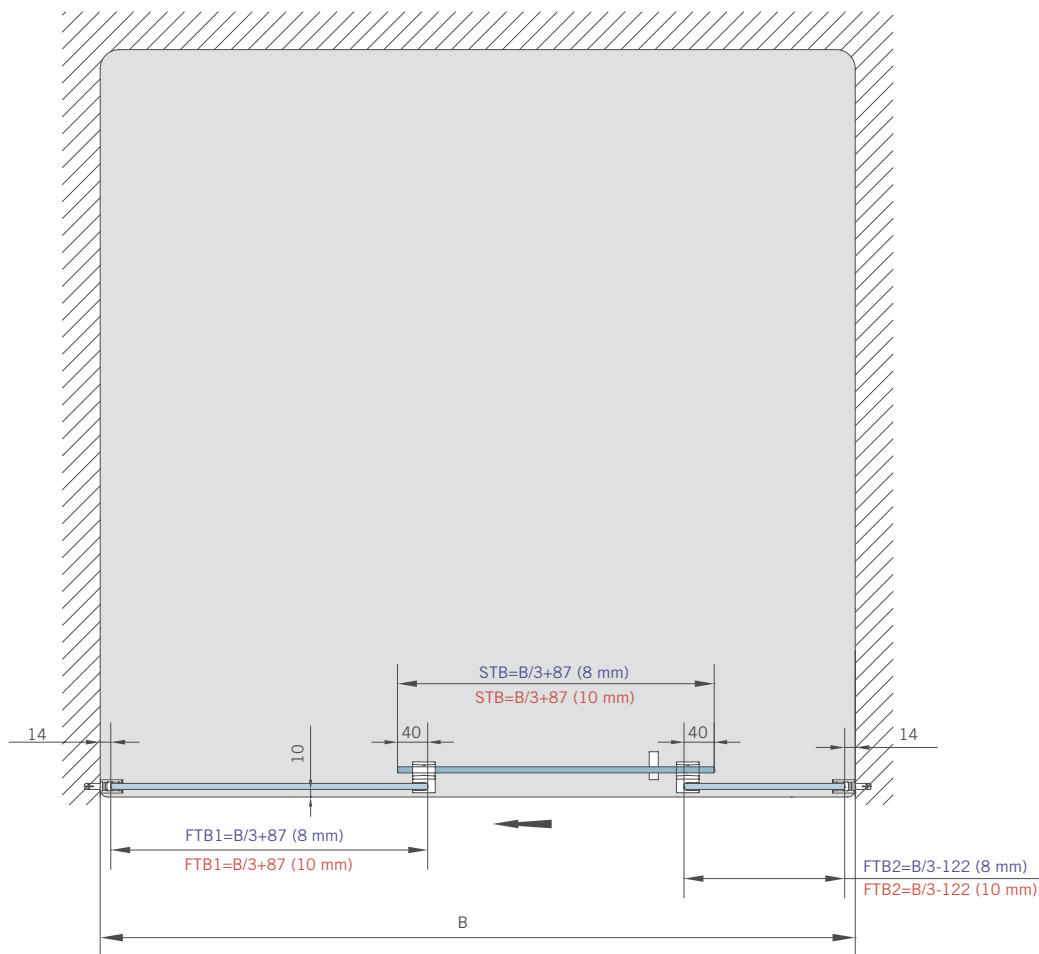

Glasbearbeitung / Aussenansicht / Für Duschen **mit/ohne** Duschtasse / DIN-links (DIN-rechts spiegelbildlich)
Glass preparation / view from outside / For showers **with/without** shower tray / DIN-left (DIN-right mirror-inverted)

